

PCF8575 Remote 16-BIT I²C AND SMBus I/O Expander with Interrupt Output

1 Features

- I²C to Parallel-Port Expander
- Open-Drain Interrupt Output
- Low Standby-Current Consumption of 10 μ A Max
- Compatible With Most Microcontrollers
- 400-kHz Fast I²C Bus
- Address by Three Hardware Address Pins for Use of up to Eight Devices
- Latched Outputs With High-Current Drive Capability for Directly Driving LEDs
- Current Source to V_{CC} for Actively Driving a High at the Output
- Latch-Up Performance Exceeds 100 mA Per JESD 78, Class II
- ESD Protection Exceeds JESD 22
 - 2000-V Human-Body Model
 - 200-V Machine Model
 - 1000-V Charged-Device Model

2 Applications

- Telecom Shelters: Filter Units
- Servers
- Routers (Telecom Switching Equipment)
- [Personal Computers](#)
- [Personal Electronics](#)
- [Industrial Automation](#)
- Products with GPIO-Limited Processors

3 Description

This 16-bit I/O expander for the two-line bidirectional bus (I²C) is designed for 2.5-V to 5.5-V V_{CC} operation.

The PCF8575 device provides general-purpose remote I/O expansion for most microcontroller families by way of the I²C interface [serial clock (SCL), serial data (SDA)].

The device features a 16-bit quasi-bidirectional input/output (I/O) port (P07–P00, P17–P10), including latched outputs with high-current drive capability for directly driving LEDs. Each quasi-bidirectional I/O can be used as an input or output without the use of a data-direction control signal. At power on, the I/Os are high. In this mode, only a current source to V_{CC} is active.

Device Information⁽¹⁾

PART NUMBER	PACKAGE (PIN)	BODY SIZE (NOM)
PCF8575	SSOP (24)	8.20 mm × 5.30 mm
	QSOP (24)	8.65 mm × 3.90 mm
	TVSOP (24)	5.00 mm × 4.50 mm
	SOIC (24)	15.40 mm × 7.50 mm
	TSSOP (24)	7.80 mm × 4.40 mm
	VQFN (24)	4.00 mm × 4.00 mm

(1) For all available packages, see the orderable addendum at the end of the data sheet.

Simplified Schematic

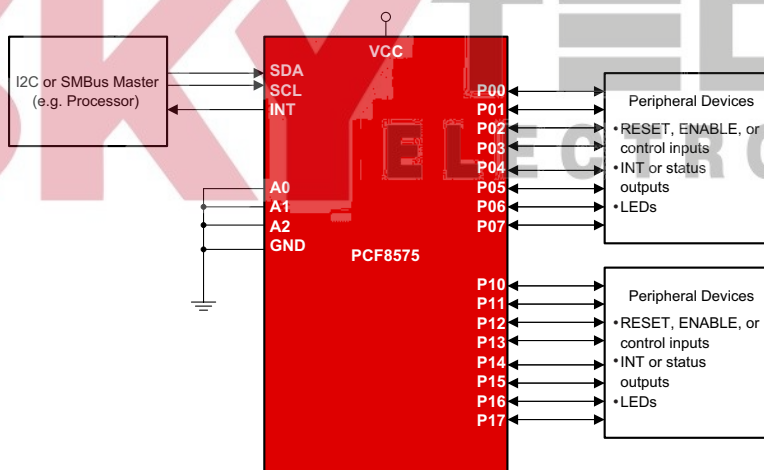

Table of Contents

1 Features	1	8.4 Device Functional Modes.....	16
2 Applications	1	9 Application and Implementation	18
3 Description	1	9.1 Application Information.....	18
4 Revision History	2	9.2 Typical Application	18
5 Pin Configuration and Functions	3	10 Power Supply Recommendations	21
6 Specifications	4	10.1 Power-On Reset.....	21
6.1 Absolute Maximum Ratings	4	10.2 System Impact	21
6.2 ESD Ratings.....	4	11 Layout	22
6.3 Recommended Operating Conditions.....	4	11.1 Layout Guidelines	22
6.4 Thermal Information	4	11.2 Layout Example	23
6.5 Electrical Characteristics.....	5	12 Device and Documentation Support	24
6.6 I ² C Interface Timing Requirements.....	5	12.1 Device Support	24
6.7 Switching Characteristics	6	12.2 Documentation Support	24
6.8 Typical Characteristics	6	12.3 Receiving Notification of Documentation Updates	24
7 Parameter Measurement Information	9	12.4 Support Resources	24
8 Detailed Description	12	12.5 Trademarks	24
8.1 Overview	12	12.6 Electrostatic Discharge Caution.....	24
8.2 Functional Block Diagram	13	12.7 Glossary	24
8.3 Feature Description.....	14	13 Mechanical, Packaging, and Orderable Information	24

4 Revision History

Changes from Revision G (August 2018) to Revision H	Page
• Changed Figure 18	16
Changes from Revision F (May 2015) to Revision G	Page
• Changed the <i>Power Supply Recommendations</i> section	21
Changes from Revision E (January 2015) to Revision F	Page
• Fixed naming typo in the RGE graphic, changed pin 3 From: P03 To: P02	3
Changes from Revision D (April 2007) to Revision E	Page
• Added <i>Applications</i> , <i>Device Information</i> table, <i>Pin Functions</i> table, <i>ESD Ratings</i> table, <i>Thermal Information</i> table, <i>Typical Characteristics</i> , <i>Feature Description</i> section, <i>Device Functional Modes</i> , <i>Application and Implementation</i> section, <i>Power Supply Recommendations</i> section, <i>Layout</i> section, <i>Device and Documentation Support</i> section, and <i>Mechanical, Packaging, and Orderable Information</i> section.....	1
• Deleted <i>Ordering Information</i> table.	1

5 Pin Configuration and Functions

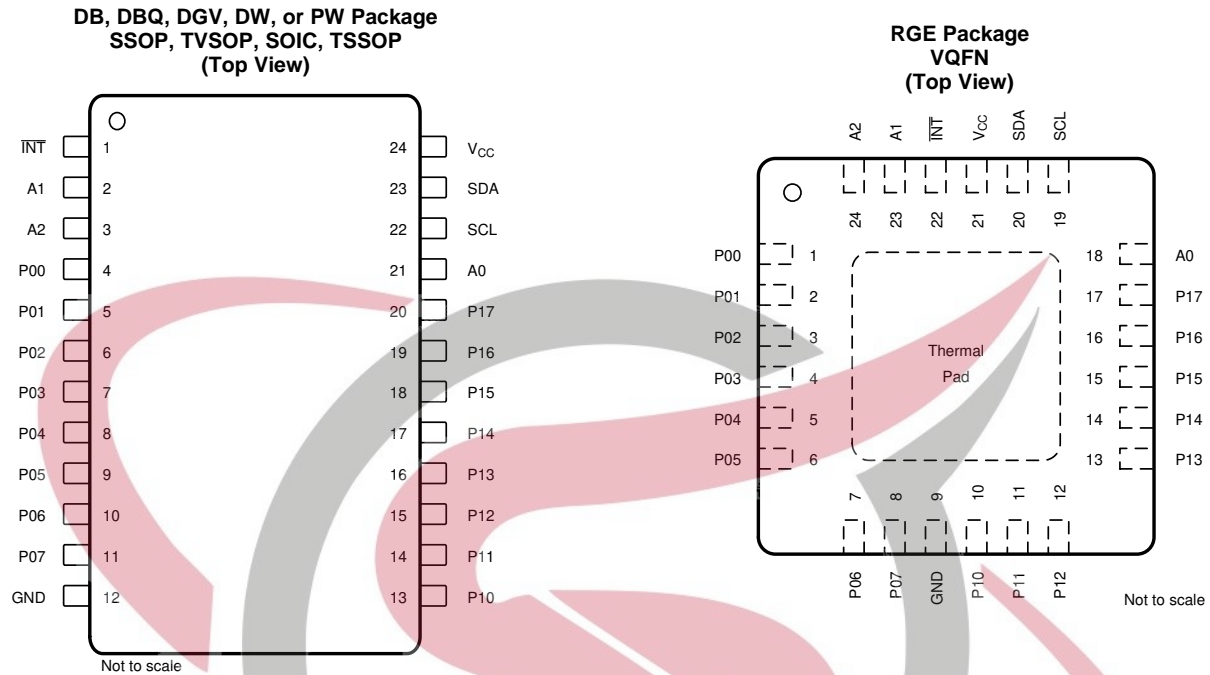

Pin Functions

NAME	PIN		TYPE	DESCRIPTION
	DB, DBQ, DGV, DW, AND PW	RGE		
A0	21	18	I	Address input 0. Connect directly to V_{CC} or ground. Pull-up resistors are not needed.
A1	2	23	I	Address input 1. Connect directly to V_{CC} or ground. Pull-up resistors are not needed.
A2	3	24	I	Address input 2. Connect directly to V_{CC} or ground. Pull-up resistors are not needed.
INT	1	22	O	Interrupt output. Connect to V_{CC} through a pull-up resistor.
P00	4	1	I/O	P-port input/output. Push-pull design structure.
P01	5	2	I/O	P-port input/output. Push-pull design structure.
P02	6	3	I/O	P-port input/output. Push-pull design structure.
P03	7	4	I/O	P-port input/output. Push-pull design structure.
P04	8	5	I/O	P-port input/output. Push-pull design structure.
P05	9	6	I/O	P-port input/output. Push-pull design structure.
P06	10	7	I/O	P-port input/output. Push-pull design structure.
P07	11	8	I/O	P-port input/output. Push-pull design structure.
GND	12	9	—	Ground
P10	13	10	I/O	P-port input/output. Push-pull design structure.
P11	14	11	I/O	P-port input/output. Push-pull design structure.
P12	15	12	I/O	P-port input/output. Push-pull design structure.
P13	16	13	I/O	P-port input/output. Push-pull design structure.
P14	17	14	I/O	P-port input/output. Push-pull design structure.
P15	18	15	I/O	P-port input/output. Push-pull design structure.
P16	19	16	I/O	P-port input/output. Push-pull design structure.
P17	20	17	I/O	P-port input/output. Push-pull design structure.
SCL	22	19	I	Serial clock line. Connect to V_{CC} through a pull-up resistor
SDA	23	20	I/O	Serial data line. Connect to V_{CC} through a pull-up resistor.
V_{CC}	24	21	—	Supply voltage

6 Specifications

6.1 Absolute Maximum Ratings

over operating free-air temperature range (unless otherwise noted)⁽¹⁾

		MIN	MAX	UNIT
V _{CC}	Supply voltage range	-0.5	6.5	V
V _I	Input voltage range ⁽²⁾	-0.5	V _{CC} + 0.5	V
V _O	Output voltage range ⁽²⁾	-0.5	V _{CC} + 0.5	V
I _{IK}	Input clamp current	V _I < 0		-20 mA
I _{OK}	Output clamp current	V _O < 0		-20 mA
I _{OK}	Input/output clamp current	V _O < 0 or V _O > V _{CC}		-20 mA
I _{OL}	Continuous output low current	V _O = 0 to V _{CC}		50 mA
I _{OH}	Continuous output high current	V _O = 0 to V _{CC}		-4 mA
	Continuous current through V _{CC} or GND			±100 mA
T _{stg}	Storage temperature range			150 °C

- (1) Stresses beyond those listed under *Absolute Maximum Ratings* may cause permanent damage to the device. These are stress ratings only, and functional operation of the device at these or any other conditions beyond those indicated under *Recommended Operating Conditions* is not implied. Exposure to absolute-maximum-rated conditions for extended periods may affect device reliability.
- (2) The input negative-voltage and output voltage ratings may be exceeded if the input and output current ratings are observed.

6.2 ESD Ratings

		VALUE	UNIT
V _(ESD)	Electrostatic discharge	Human body model (HBM), per ANSI/ESDA/JEDEC JS-001, all pins	2000
		Charged device model (CDM), per JEDEC specification JESD22-C101, all pins	1000

6.3 Recommended Operating Conditions

		MIN	MAX	UNIT
V _{CC}	Supply voltage	2.5	5.5	V
V _{IH}	High-level input voltage	0.7 × V _{CC}	V _{CC} + 0.5	V
V _{IL}	Low-level input voltage	-0.5	0.3 × V _{CC}	V
I _{OH}	P-port high-level output current			-1 mA
I _{OHT}	P-port transient pullup current			-10 mA
I _{OL}	P-port low-level output current			25 mA
T _A	Operating free-air temperature	-40	85	°C

6.4 Thermal Information

THERMAL METRIC ⁽¹⁾	PCF8575							UNIT
	DB	DBQ	DGV	DW	PW	RGE		
	24 PINS							
R _{θJA}	Junction-to-ambient thermal resistance	63	61	86	46	88	53	°C/W

- (1) For more information about traditional and new thermal metrics, see the *Semiconductor and IC Package Thermal Metrics* application report.

6.5 Electrical Characteristics

over recommended operating free-air temperature range (unless otherwise noted)

PARAMETER		TEST CONDITIONS	V _{CC}	MIN	TYP ⁽¹⁾	MAX	UNIT
V _{IK}	Input diode clamp voltage	I _I = -18 mA	2.5 V to 5.5 V	-1.2			V
V _{POR}	Power-on reset voltage ⁽²⁾	V _I = V _{CC} or GND, I _O = 0	V _{POR}		1.2	1.8	V
I _{OH}	P port	V _O = GND	2.5 V to 5.5 V	-30		-300	μA
I _{OHT}	P-port transient pullup current	High during ACK, V _{OH} = GND	2.5 V	-0.5	-1		mA
I _{OL}	SDA	V _{OL} = 0.4 V	2.5 V to 5.5 V	3		mA	
	P port	V _{OL} = 0.4 V		5 15			
		V _{OL} = 1 V		10 25			
	$\overline{\text{INT}}$	V _{OL} = 0.4 V		1.6			
I _I	SCL, SDA	V _I = V _{CC} or GND	2.5 V to 5.5 V			±5	μA
	A0, A1, A2					±1	
I _{IHL}	P port	V _I ≥ V _{CC} or V _I ≤ GND	2.5 V to 5.5 V			±400	μA
I _{CC}	Operating mode	V _I = V _{CC} or GND, I _O = 0, f _{scl} = 400 kHz	5.5 V	100 200		μA	
			3.6 V	30 75			
			2.7 V	20 50			
	Standby mode	V _I = V _{CC} or GND, I _O = 0, f _{scl} = 0 kHz	5.5 V	2.5 10			
			3.6 V	2.5 10			
		2.7 V	2.5 10				
ΔI _{CC}	Supply current increase	One input at V _{CC} - 0.6 V, Other inputs at V _{CC} or GND	2.5 V to 5.5 V			200	μA
C _I	SCL	V _I = V _{CC} or GND	2.5 V to 5.5 V	3 7		pF	
C _{io}	SDA	V _{IO} = V _{CC} or GND	2.5 V to 5.5 V	3 7		pF	
	P port			4 10			

(1) All typical values are at nominal supply voltage (2.5-V, 3.3-V, or 5-V V_{CC}) and T_A = 25°C.

(2) The power-on reset circuit resets the I²C bus logic with V_{CC} < V_{POR} and sets all I/Os to logic high (with current source to V_{CC}).

6.6 I²C Interface Timing Requirements

over recommended operating free-air temperature range (unless otherwise noted) (see Figure 12)

		MIN	MAX	UNIT
f _{scl}	I ² C clock frequency		400	kHz
t _{sch}	I ² C clock high time	0.6		μs
t _{scl}	I ² C clock low time	1.3		μs
t _{sp}	I ² C spike time		50	ns
t _{sds}	I ² C serial data setup time	100		ns
t _{sdh}	I ² C serial data hold time	0		ns
t _{icr}	I ² C input rise time	20 + 0.1C _b ⁽¹⁾	300	ns
t _{icf}	I ² C input fall time	20 + 0.1C _b ⁽¹⁾	300	ns
t _{ocf}	I ² C output fall time	10-pF to 400-pF bus	300	ns
t _{buf}	I ² C bus free time between Stop and Start	1.3		μs
t _{sts}	I ² C start or repeated Start condition setup	0.6		μs
t _{sth}	I ² C start or repeated Start condition hold	0.6		μs
t _{sps}	I ² C Stop condition setup	0.6		μs
t _{vd}	Valid-data time	SCL low to SDA output valid	1.2	μs
C _b	I ² C bus capacitive load		400	pF

(1) C_b = total bus capacitance of one bus line in pF

6.7 Switching Characteristics

over recommended operating free-air temperature range, $C_L \leq 100$ pF (unless otherwise noted) (see Figure 13 and Figure 14)

PARAMETER	FROM (INPUT)	TO (OUTPUT)	MIN	MAX	UNIT
t_{iv}	Interrupt valid time	P port		4	μ s
t_{ir}	Interrupt reset delay time	SCL		4	μ s
t_{pv}	Output data valid	SCL		4	μ s
t_{su}	Input data setup time	P port	0		μ s
t_h	Input data hold time	P port	4		μ s

6.8 Typical Characteristics

$T_A = 25^\circ\text{C}$ (unless otherwise noted)

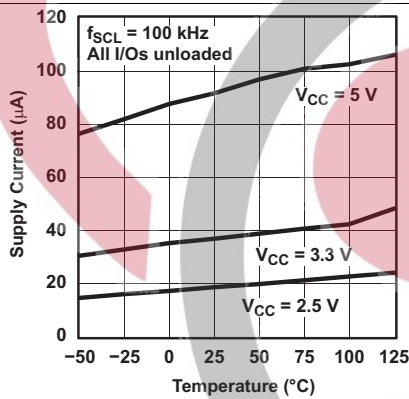

Figure 1. Supply Current vs Temperature

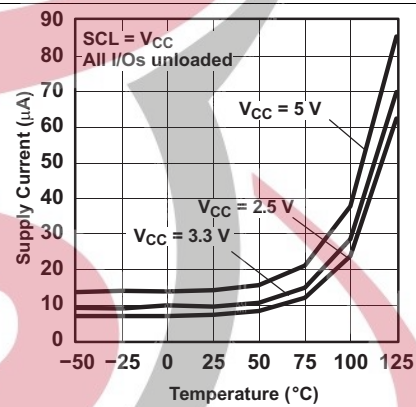

Figure 2. Standby Supply Current vs Temperature

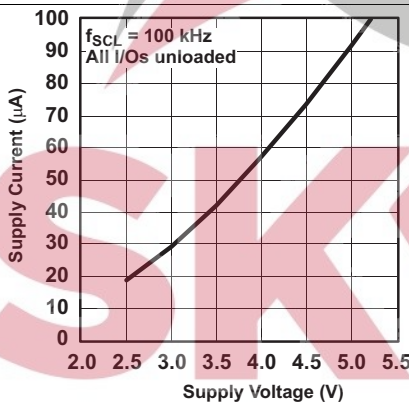

Figure 3. Supply Current vs Supply Voltage

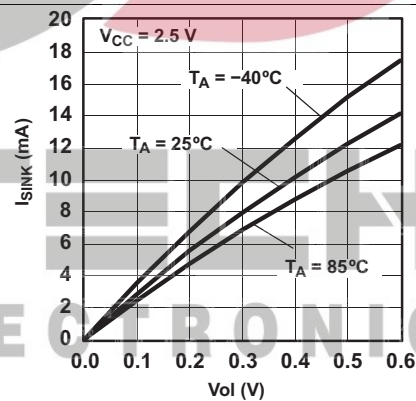

Figure 4. I/O Sink Current vs Output Low Voltage

Typical Characteristics (continued)

T_A = 25°C (unless otherwise noted)

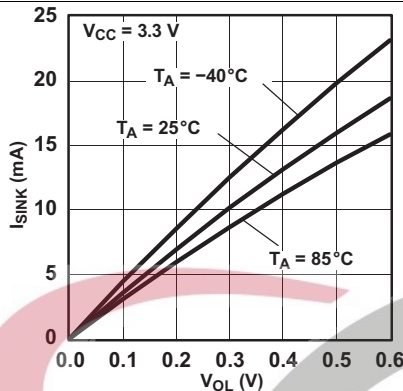

Figure 5. I/O Sink Current vs Output Low Voltage

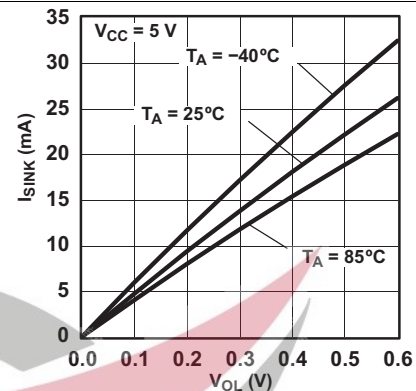

Figure 6. I/O Sink Current vs Output Low Voltage

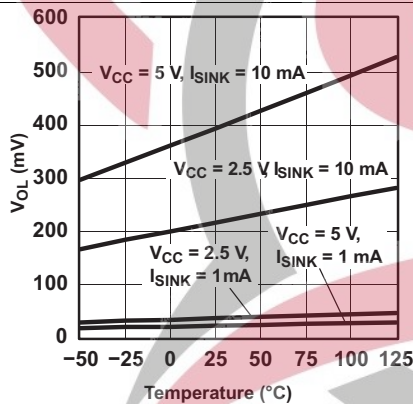

Figure 7. I/O Output Low Voltage vs Temperature

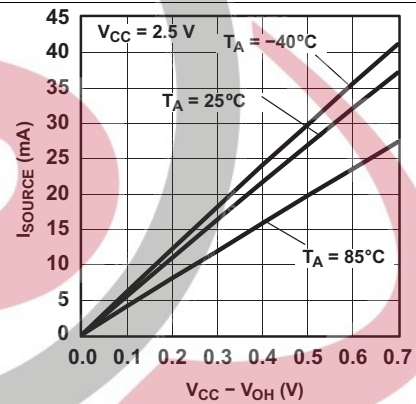

Figure 8. I/O Source Current vs Output High Voltage

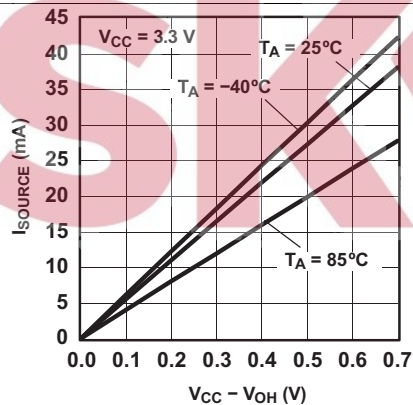

Figure 9. I/O Source Current vs Output High Voltage

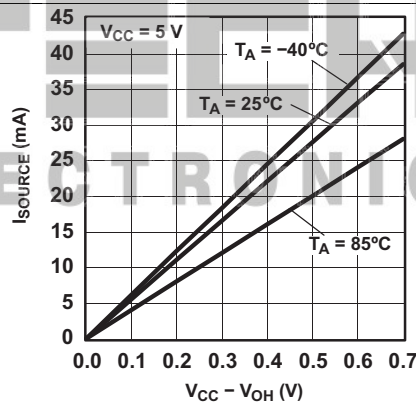
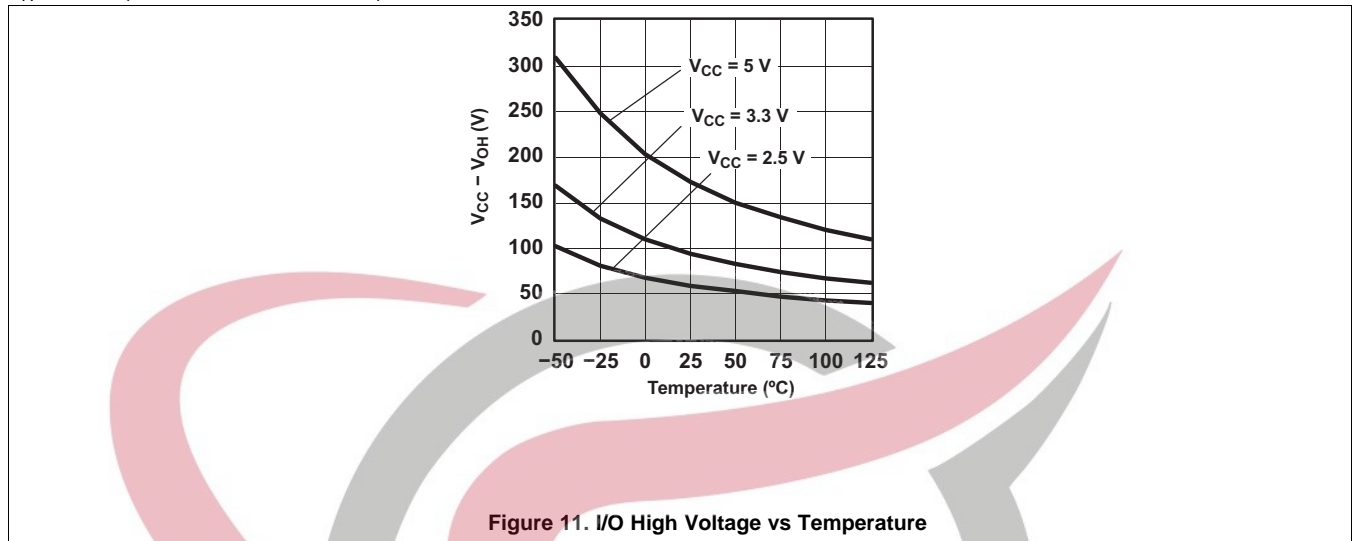

Figure 10. I/O Source Current vs Output High Voltage

Typical Characteristics (continued)

T_A = 25°C (unless otherwise noted)



7 Parameter Measurement Information

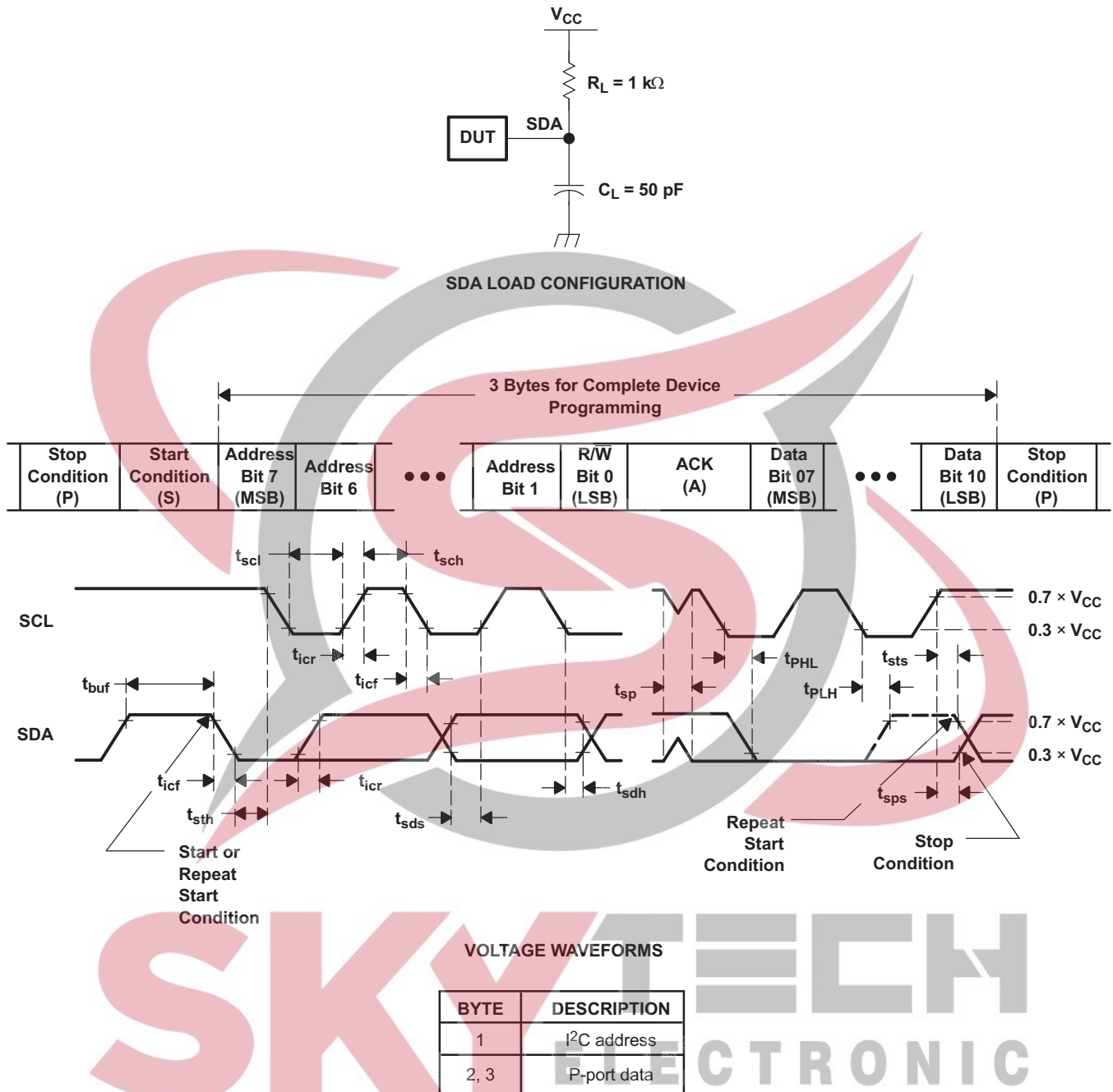

Figure 12. I²C Interface Load Circuit and Voltage Waveforms

Parameter Measurement Information (continued)

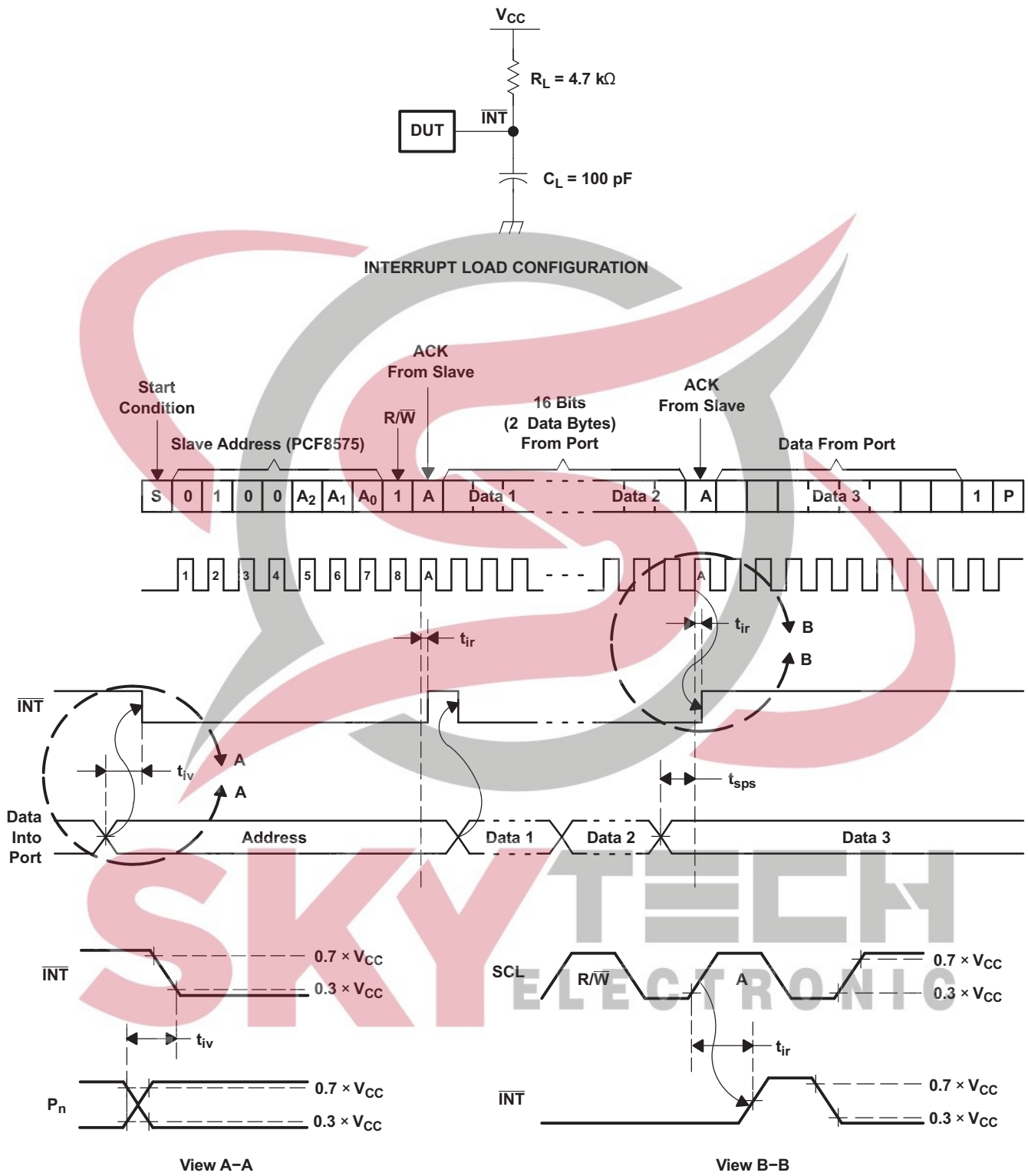

Figure 13. Interrupt Load Circuit and Voltage Waveforms

Parameter Measurement Information (continued)

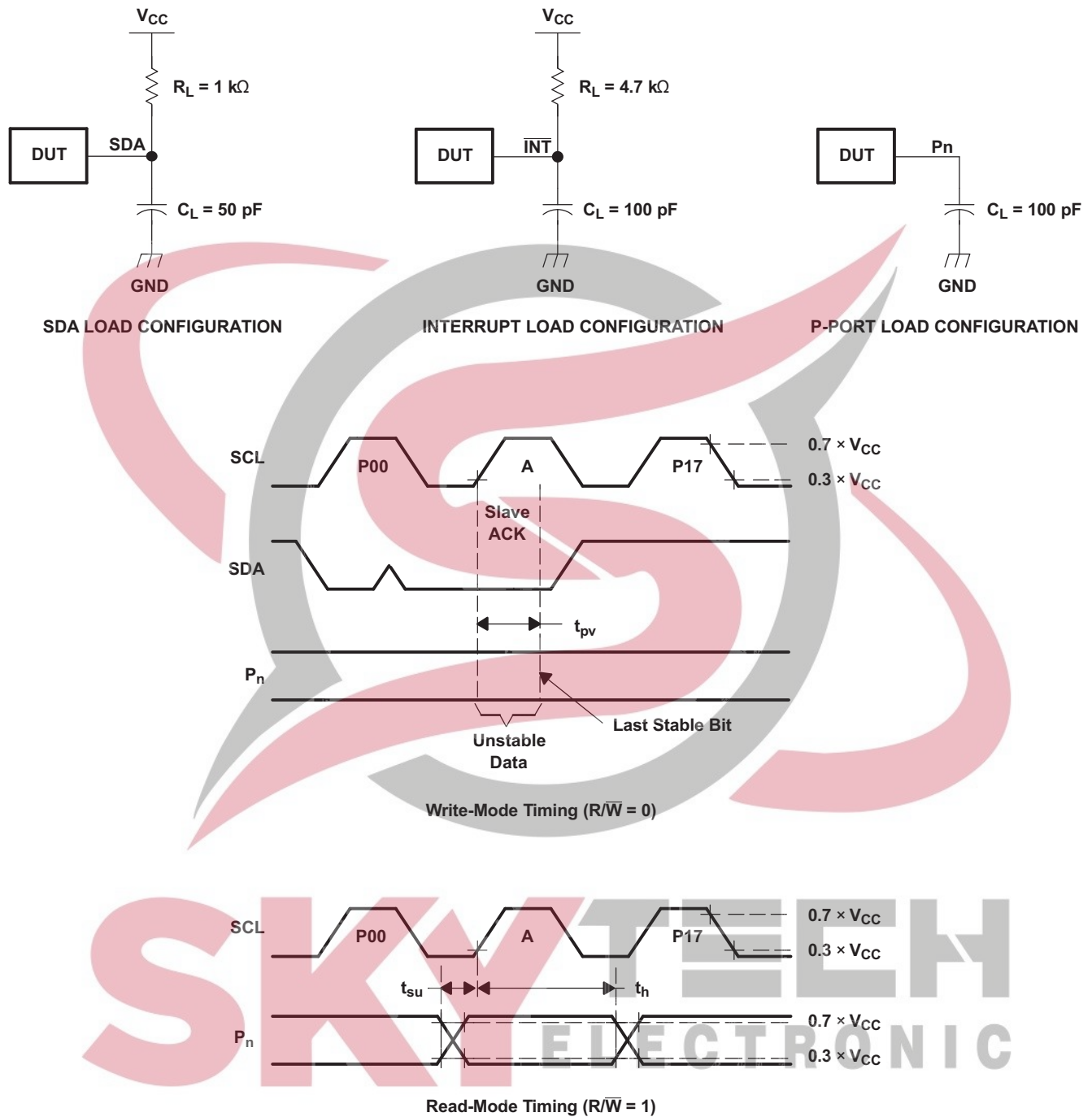

Figure 14. P-Port Load Circuits and Voltage Waveforms

8 Detailed Description

8.1 Overview

The PCF8575 provides general-purpose remote I/O expansion for most microcontroller families via the I²C interface serial clock (SCL) and serial data (SDA).

The device features a 16-bit quasi-bidirectional input/output (I/O) port (P07–P00, P17–P10), including latched outputs with high-current drive capability for directly driving LEDs. Each quasi-bidirectional I/O can be used as an input or output without the use of a data-direction control signal. At power on, the I/Os are high. In this mode, only a current source (I_{OH}) to V_{CC} is active. An additional strong pullup to V_{CC} (I_{OHT}) allows fast-rising edges into heavily loaded outputs. This device turns on when an output is written high and is switched off by the negative edge of SCL. The I/Os should be high before being used as inputs. After power on, as all the I/Os are set high, all of them can be used as inputs. Any change in setting of the I/Os as either input or outputs can be done with the write mode. If a high is applied externally to an I/O that has been written earlier to low, a large current (I_{OL}) will flow to GND.

The PCF8575 provides an open-drain interrupt (\overline{INT}) output, which can be connected to the interrupt input of a microcontroller. An interrupt is generated by any rising or falling edge of the port inputs in the input mode. After time, t_{iv} , the signal \overline{INT} is valid. Resetting and reactivating the interrupt circuit is achieved when data on the port is changed to the original setting, or data is read from or written to the port that generated the interrupt. Resetting occurs in the read mode at the acknowledge (ACK) bit after the rising edge of the SCL signal or in the write mode at the ACK bit after the falling edge of the SCL signal. Interrupts that occur during the ACK clock pulse can be lost (or be very short), due to the resetting of the interrupt during this pulse. Each change of the I/Os after resetting is detected and is transmitted as \overline{INT} . Reading from or writing to another device does not affect the interrupt circuit. This device does not have internal configuration or status registers. Instead, read or write to the device I/Os directly after sending the device address (see [Figure 18](#) and [Figure 19](#)).

By sending an interrupt signal on this line, the remote I/O can inform the microcontroller if there is incoming data on its ports, without having to communicate via the I²C bus. Thus, the PCF8575 can remain a simple slave device.

Every data transmission to or from the PCF8575 must consist of an even number of bytes. The first data byte in every pair refers to port 0 (P07–P00), and the second data byte in every pair refers to port 1 (P17–P10). To write to the ports (output mode), the master first addresses the slave device, setting the last bit of the byte containing the slave address to logic 0. The PCF8575 acknowledges, and the master sends the first data byte for P07–P00. After the first data byte is acknowledged by the PCF8575, the second data byte (P17–P10) is sent by the master. Once again, the PCF8575 acknowledges the receipt of the data, after which this 16-bit data is presented on the port lines.

The number of data bytes that can be sent successively is not limited. After every two bytes, the previous data is overwritten. When the PCF8575 receives the pairs of data bytes, the first byte is referred to as P07–P00 and the second byte as P17–P10. The third byte is referred to as P07–P00, the fourth byte as P17–P10, and so on.

Before reading from the PCF8575, all ports desired as input should be set to logic 1. To read from the ports (input mode), the master first addresses the slave device, setting the last bit of the byte containing the slave address to logic 1. The data bytes that follow on the SDA are the values on the ports. If the data on the input port changes faster than the master can read, this data may be lost.

When power is applied to V_{CC} , an internal power-on reset holds the PCF8575 in a reset state until V_{CC} has reached V_{POR} . At that time, the reset condition is released, and the device I²C-bus state machine initializes the bus to its default state.

The hardware pins (A0, A1, and A2) are used to program and vary the fixed I²C address and allow up to eight devices to share the same I²C bus or SMBus. The fixed I²C address of the PCF8575 is the same as the PCF8575C, PCF8574, PCA9535, and PCA9555, allowing up to eight of these devices, in any combination, to share the same I²C bus or SMBus.

8.2 Functional Block Diagram

8.2.1 Logic Diagram (Positive Logic)

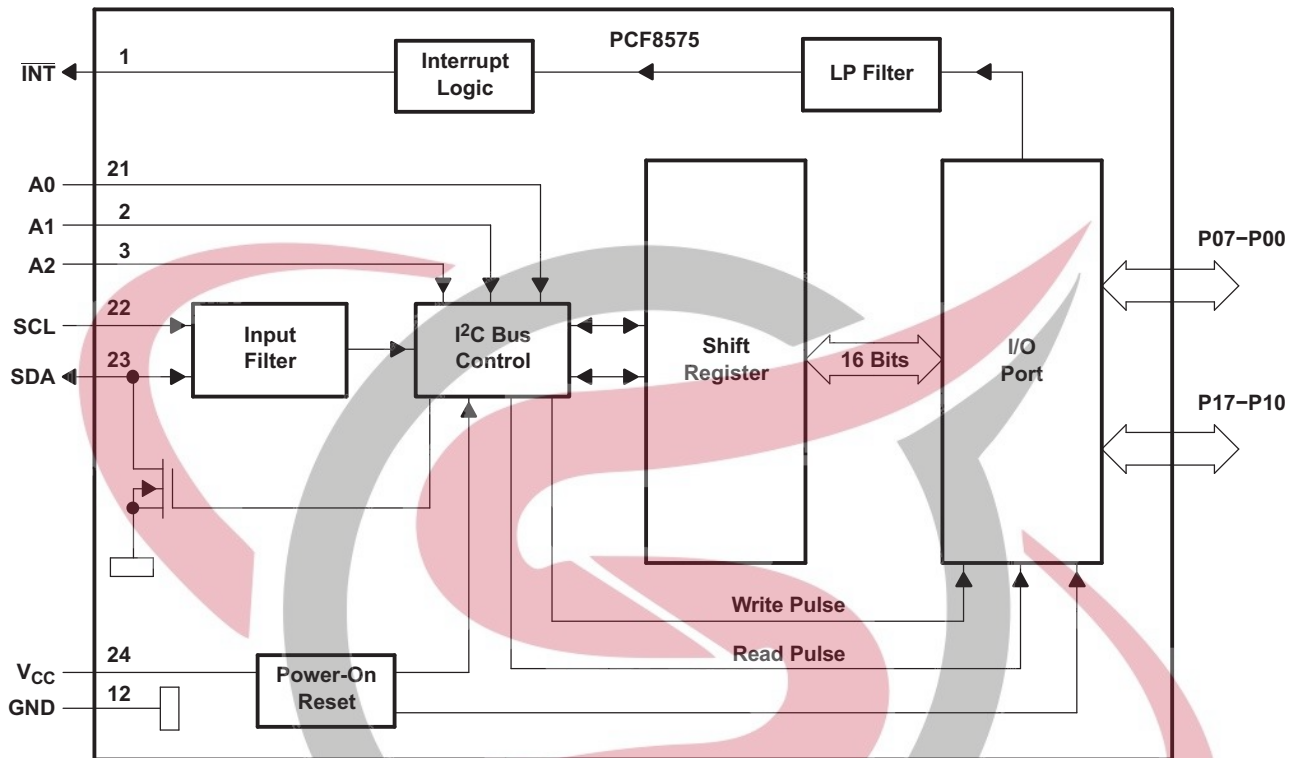

8.2.2 Simplified Schematic Diagram of Each P-Port Input/Output

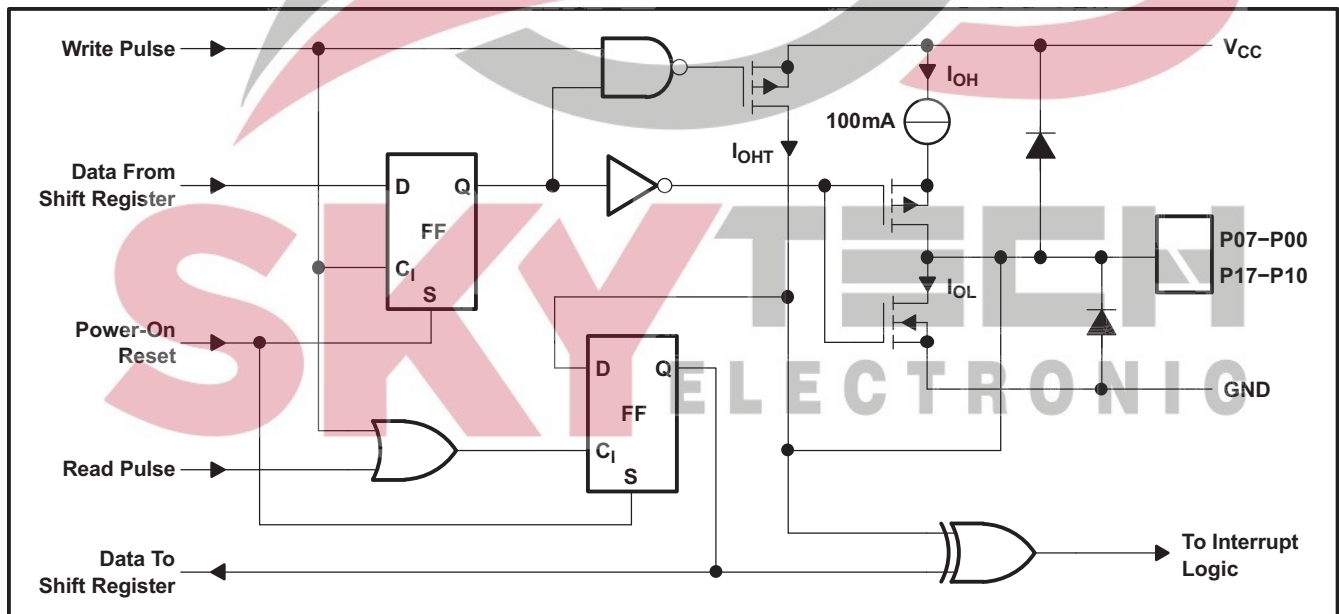

8.3 Feature Description

8.3.1 I²C Interface

The bidirectional I²C bus consists of the serial clock (SCL) and serial data (SDA) lines. Both lines must be connected to a positive supply via a pullup resistor when connected to the output stages of a device. Data transfer may be initiated only when the bus is not busy.

I²C communication with this device is initiated by a master sending a Start condition, a high-to-low transition on the SDA input/output while the SCL input is high (see Figure 15). After the Start condition, the device address byte is sent, most significant bit (MSB) first, including the data direction bit (R/W). This device does not respond to the general call address. After receiving the valid address byte, this device responds with an ACK, a low on the SDA input/output during the high of the ACK-related clock pulse. The address inputs (A2–A0) of the slave device must not be changed between the Start and Stop conditions.

The data byte follows the address ACK. If the R/W bit is high, the data from this device are the values read from the P port. If the R/W bit is low, the data are from the master, to be output to the P port. The data byte is followed by an ACK sent from this device. If other data bytes are sent from the master, following the ACK, they are ignored by this device. Data are output only if complete bytes are received and acknowledged. The output data is valid at time (t_{pv}) after the low-to-high transition of SCL, during the clock cycle for the ACK.

On the I²C bus, only one data bit is transferred during each clock pulse. The data on the SDA line must remain stable during the high pulse of the clock period, as changes in the data line at this time are interpreted as control commands (Start or Stop) (see Figure 16).

A Stop condition, a low-to-high transition on the SDA input/output while the SCL input is high, is sent by the master (see Figure 15).

The number of data bytes transferred between the Start and Stop conditions from transmitter to receiver is not limited. Each byte of eight bits is followed by one ACK bit. The transmitter must release the SDA line before the receiver can send an ACK bit.

A slave receiver that is addressed must generate an ACK after the reception of each byte. Also, a master must generate an ACK after the reception of each byte that has been clocked out of the slave transmitter. The device that acknowledges has to pull down the SDA line during the ACK clock pulse so that the SDA line is stable low during the high pulse of the ACK-related clock period (see Figure 17). Setup and hold times must be taken into account.

A master receiver must signal an end of data to the transmitter by not generating an acknowledge (NACK) after the last byte that has been clocked out of the slave. This is done by the master receiver by holding the SDA line high. In this event, the transmitter must release the data line to enable the master to generate a Stop condition.

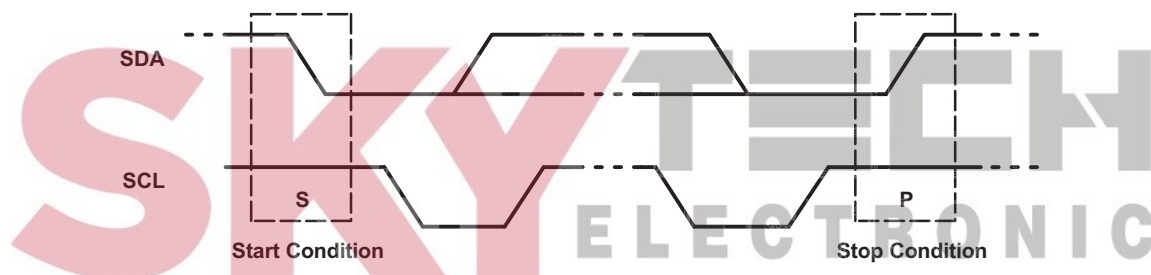

Figure 15. Definition of Start and Stop Conditions

Feature Description (continued)

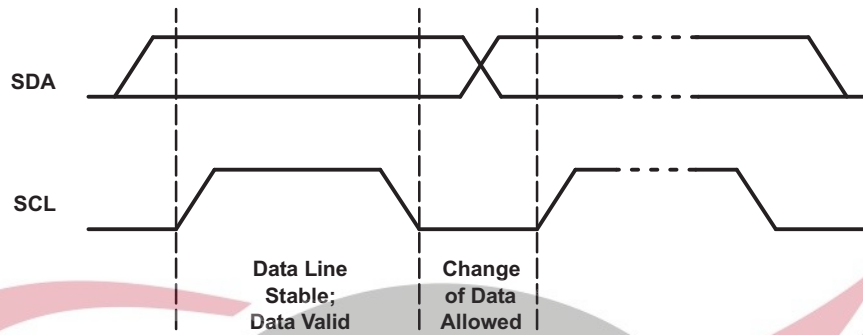

Figure 16. Bit Transfer

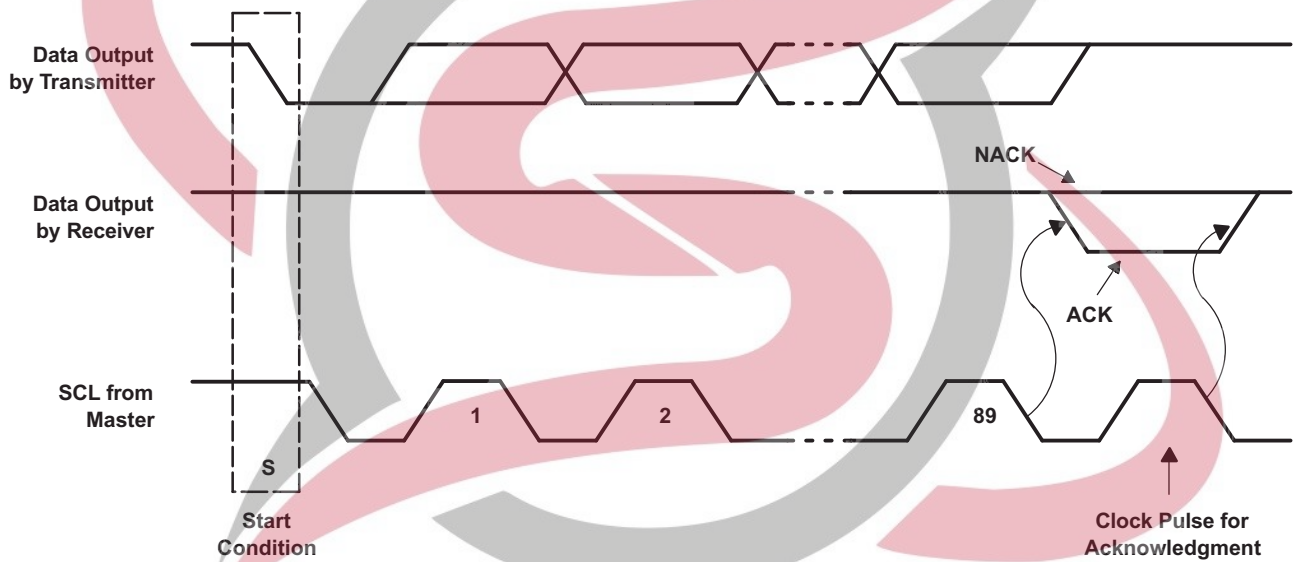

Figure 17. Acknowledgment on I²C Bus

8.3.2 Interface Definition

BYTE	BIT							
	7 (MSB)	6	5	4	3	2	1	0 (LSB)
I ² C slave address	L	H	L	L	A2	A1	A0	R/W
P0x I/O data bus	P07	P06	P05	P04	P03	P02	P01	P00
P1x I/O data bus	P17	P16	P15	P14	P13	P12	P11	P10

8.3.3 Address Reference

INPUTS			I ² C BUS SLAVE 8-BIT READ ADDRESS	I ² C BUS SLAVE 8-BIT WRITE ADDRESS
A2	A1	A0		
L	L	L	65 (decimal), 41 (hexadecimal)	64 (decimal), 40 (hexadecimal)
L	L	H	67 (decimal), 43 (hexadecimal)	66 (decimal), 42 (hexadecimal)
L	H	L	69 (decimal), 45 (hexadecimal)	68 (decimal), 44 (hexadecimal)
L	H	H	71 (decimal), 47 (hexadecimal)	70 (decimal), 46 (hexadecimal)
H	L	L	73 (decimal), 49 (hexadecimal)	72 (decimal), 48 (hexadecimal)
H	L	H	75 (decimal), 4B (hexadecimal)	74 (decimal), 4A (hexadecimal)
H	H	L	77 (decimal), 4D (hexadecimal)	76 (decimal), 4C (hexadecimal)
H	H	H	79 (decimal), 4F (hexadecimal)	78 (decimal), 4E (hexadecimal)

8.4 Device Functional Modes

Figure 18 and Figure 19 show the address and timing diagrams for the write and read modes, respectively.

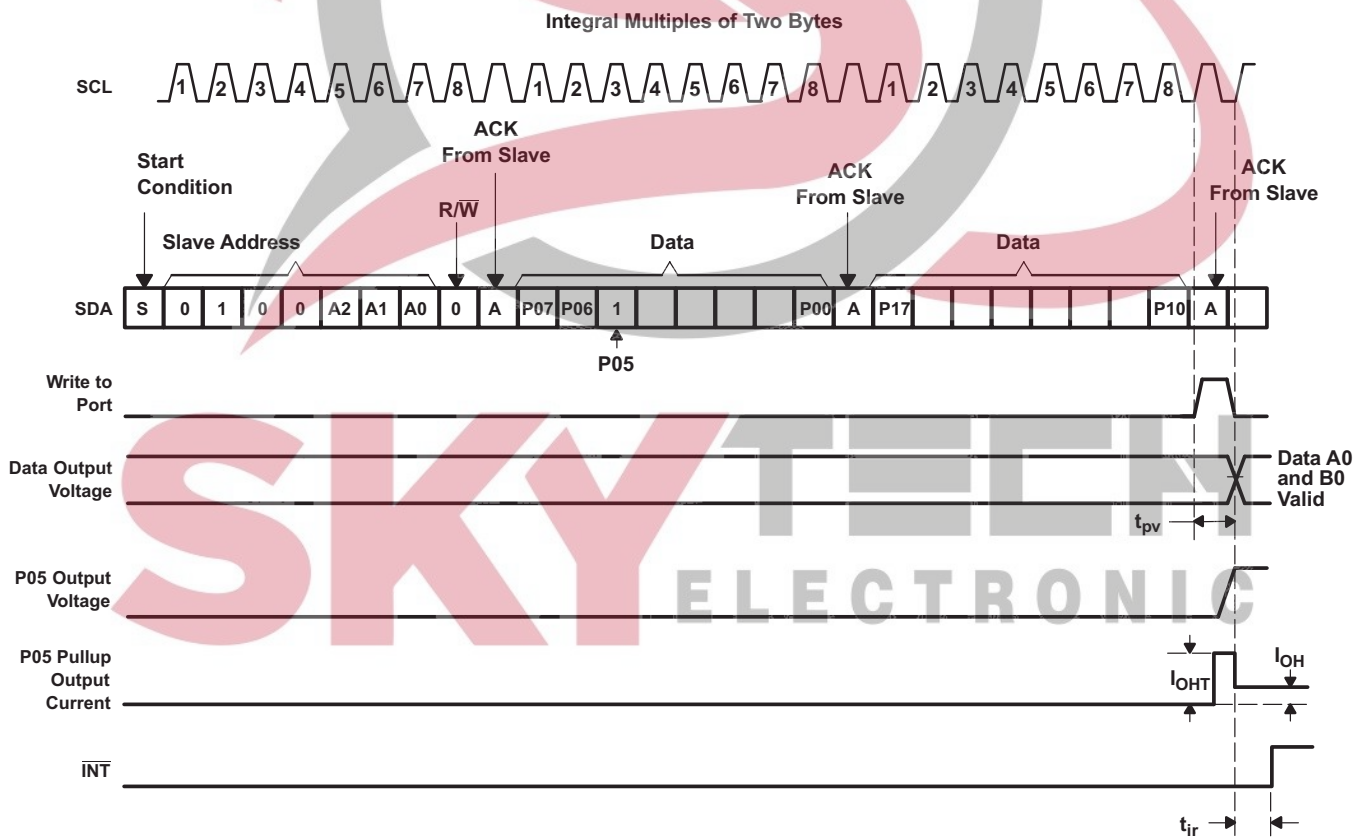

Figure 18. Write Mode (Output)

Device Functional Modes (continued)

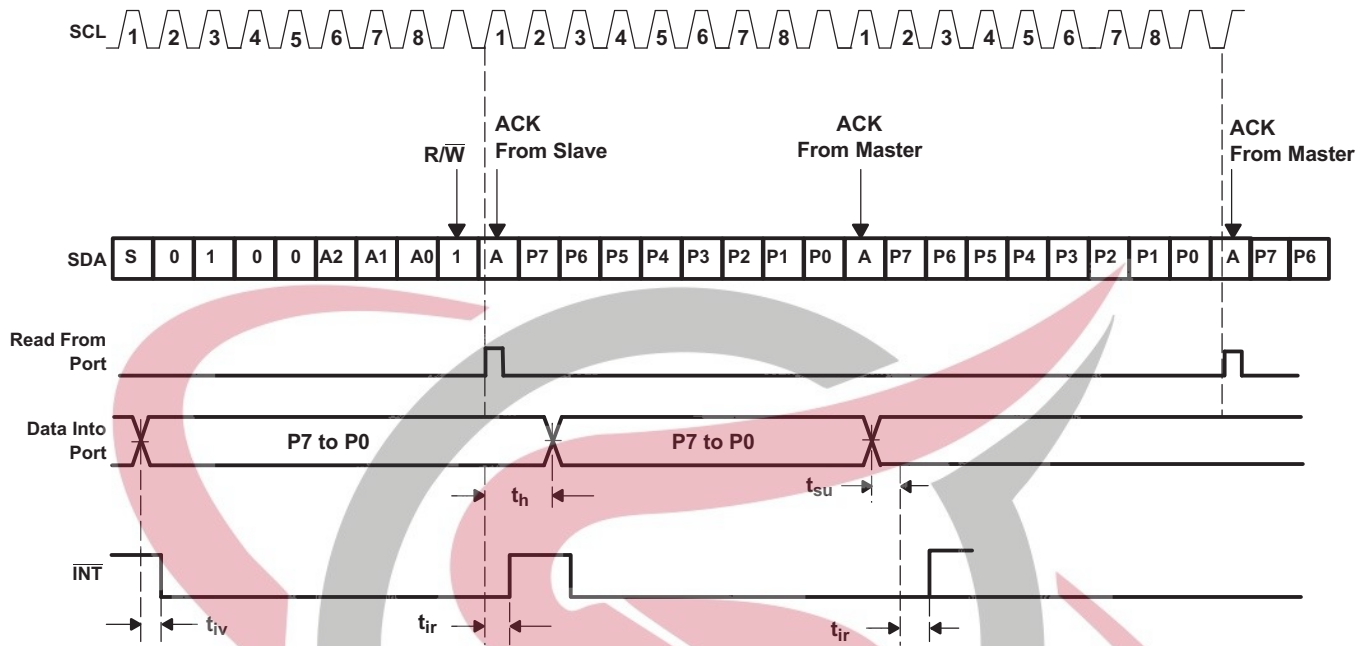

Figure 19. Read Mode (Input)



9 Application and Implementation

NOTE

Information in the following applications sections is not part of the TI component specification, and TI does not warrant its accuracy or completeness. TI's customers are responsible for determining suitability of components for their purposes. Customers should validate and test their design implementation to confirm system functionality.

9.1 Application Information

Figure 20 shows an application in which PCF8575 can be used.

9.2 Typical Application

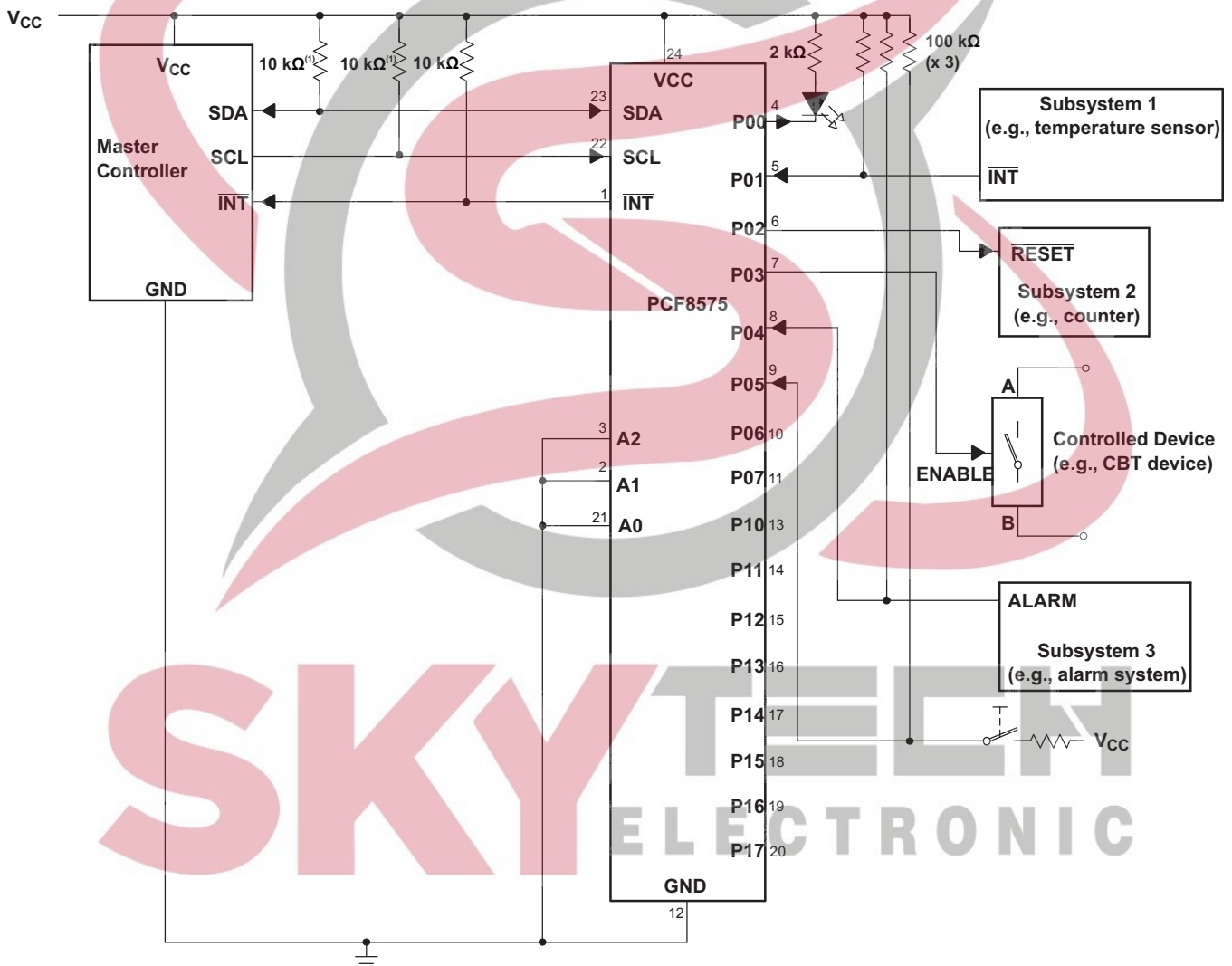

- (1) The SCL and SDA pins must be tied directly to VCC because if SCL and SDA are tied to an auxiliary power supply that could be powered on while VCC is powered off, then the supply current, ICC, will increase as a result.
- A. Device address is configured as 0100000 for this example.
- B. P0, P2, and P3 are configured as outputs.
- C. P1, P4, and P5 are configured as inputs.
- D. P6 and P7 are not used and must be configured as outputs.

Figure 20. Application Schematic

Typical Application (continued)

9.2.1 Design Requirements

9.2.1.1 Minimizing I_{CC} When I/Os Control LEDs

When the I/Os are used to control LEDs, normally they are connected to V_{CC} through a resistor as shown in Figure 20. For a P-port configured as an input, I_{CC} increases as V_I becomes lower than V_{CC} . The LED is a diode, with threshold voltage V_T , and when a P-port is configured as an input the LED will be off but V_I is a V_T drop below V_{CC} .

For battery-powered applications, it is essential that the voltage of P-ports controlling LEDs is greater than or equal to V_{CC} when the P-ports are configured as input to minimize current consumption. Figure 21 shows a high-value resistor in parallel with the LED. Figure 22 shows V_{CC} less than the LED supply voltage by at least V_T . Both of these methods maintain the I/O V_I at or above V_{CC} and prevents additional supply current consumption when the P-port is configured as an input and the LED is off.

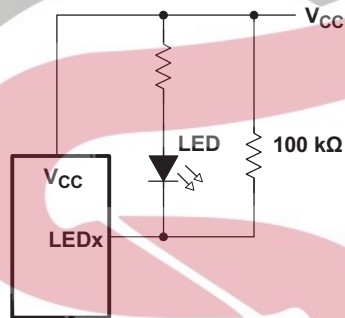

Figure 21. High-Value Resistor in Parallel With LED

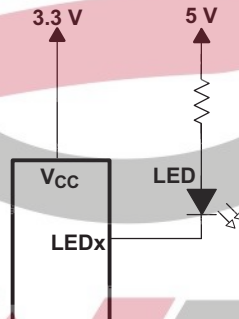

Figure 22. Device Supplied by a Lower Voltage

SKYTECH
ELECTRONIC

Typical Application (continued)

9.2.2 Detailed Design Procedure

The pull-up resistors, R_p , for the SCL and SDA lines need to be selected appropriately and take into consideration the total capacitance of all slaves on the I²C bus. The minimum pull-up resistance is a function of V_{CC} , $V_{OL(max)}$, and I_{OL} :

$$R_{p(min)} = \frac{V_{CC} - V_{OL(max)}}{I_{OL}} \tag{1}$$

The maximum pull-up resistance is a function of the maximum rise time, t_r (300 ns for fast-mode operation, $f_{SCL} = 400$ kHz) and bus capacitance, C_b :

$$R_{p(max)} = \frac{t_r}{0.8473 \times C_b} \tag{2}$$

The maximum bus capacitance for an I²C bus must not exceed 400 pF for standard-mode or fast-mode operation. The bus capacitance can be approximated by adding the capacitance of the PCF8575, C_i for SCL or C_{io} for SDA, the capacitance of wires/connections/traces, and the capacitance of additional slaves on the bus.

9.2.3 Application Curves

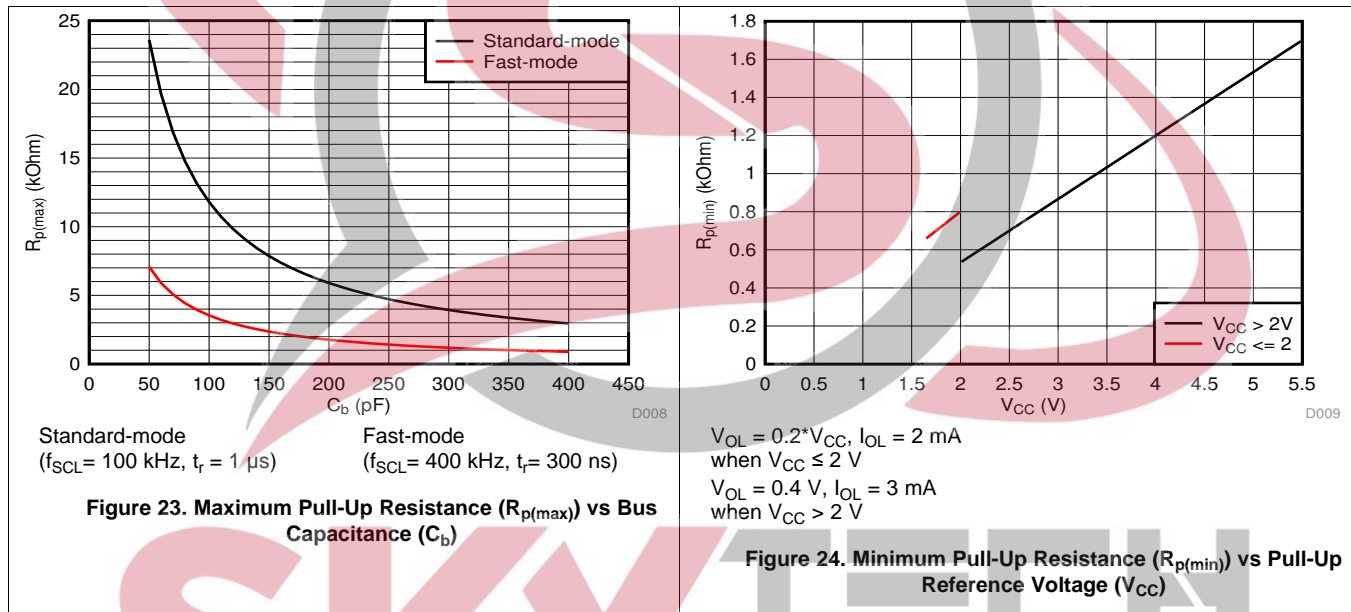

10 Power Supply Recommendations

The operating power-supply voltage range of the PCF8575 is 2.5 V to 5.5 V applied at the VCC pin. When the PCF8575 is powered on for the first time or anytime the device needs to be reset by cycling the power supply, the power-on reset requirements must be followed to ensure the I²C bus logic is initialized properly.

10.1 Power-On Reset

A power-on reset condition can be missed if the VCC ramps are outside specification listed below.

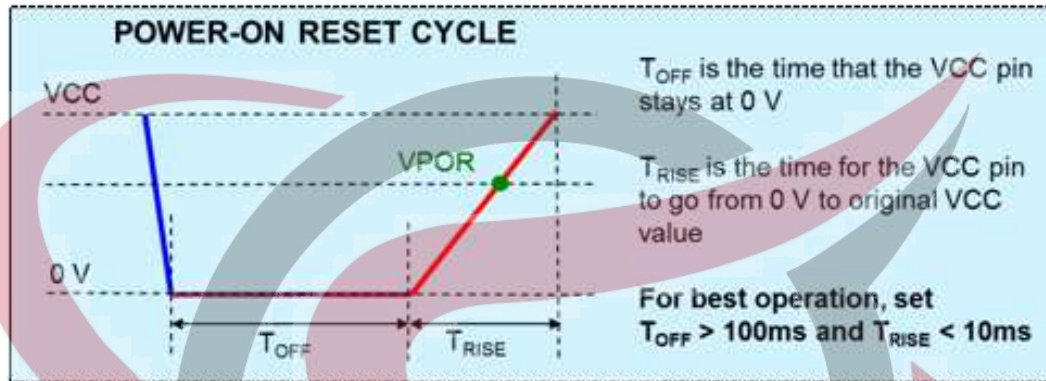

10.2 System Impact

If ramp conditions are outside timing allowances above, POR condition can be missed, causing the device to lock up.

SKYTECH
ELECTRONIC

11 Layout

11.1 Layout Guidelines

For printed circuit board (PCB) layout of the PCF8575 device, common PCB layout practices should be followed but additional concerns related to high-speed data transfer such as matched impedances and differential pairs are not a concern for I²C signal speeds.

In all PCB layouts, it is a best practice to avoid right angles in signal traces, to fan out signal traces away from each other upon leaving the vicinity of an integrated circuit (IC), and to use thicker trace widths to carry higher amounts of current that commonly pass through power and ground traces. By-pass and de-coupling capacitors are commonly used to control the voltage on the V_{CC} pin, using a larger capacitor to provide additional power in the event of a short power supply glitch and a smaller capacitor to filter out high-frequency ripple. These capacitors should be placed as close to the PCF8575 as possible. These best practices are shown in [Figure 25](#).

For the layout example provided in [Figure 25](#), it would be possible to fabricate a PCB with only 2 layers by using the top layer for signal routing and the bottom layer as a split plane for power (V_{CC}) and ground (GND). However, a 4 layer board is preferable for boards with higher density signal routing. On a 4 layer PCB, it is common to route signals on the top and bottom layer, dedicate one internal layer to a ground plane, and dedicate the other internal layer to a power plane. In a board layout using planes or split planes for power and ground, vias are placed directly next to the surface mount component pad which needs to attach to V_{CC} or GND and the via is connected electrically to the internal layer or the other side of the board. Vias are also used when a signal trace needs to be routed to the opposite side of the board, but this technique is not demonstrated in [Figure 25](#).



11.2 Layout Example

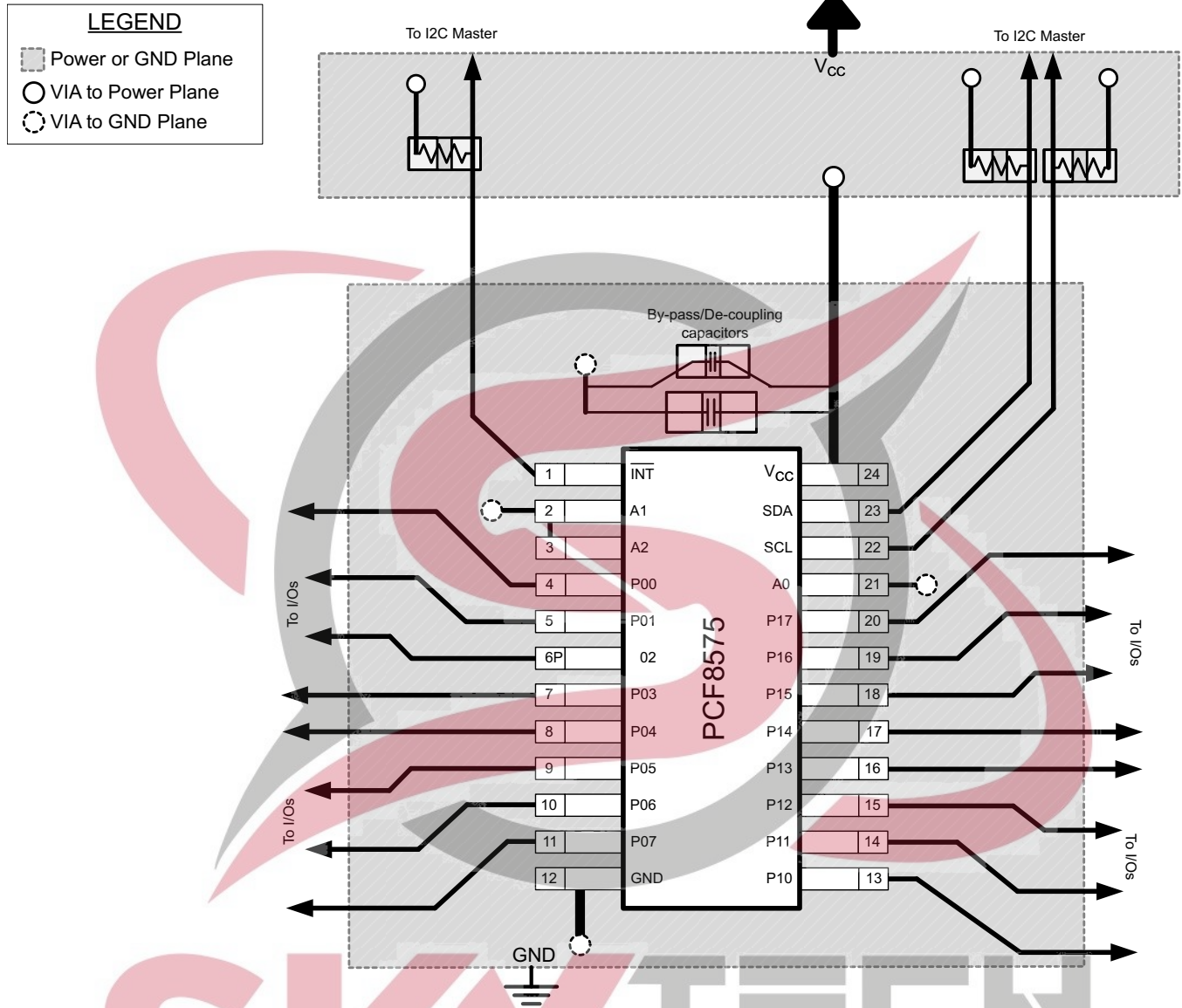

Figure 25. Layout Example for PCF8575

12 Device and Documentation Support

12.1 Device Support

12.2 Documentation Support

12.3 Receiving Notification of Documentation Updates

To receive notification of documentation updates, navigate to the device product folder on ti.com. In the upper right corner, click on *Alert me* to register and receive a weekly digest of any product information that has changed. For change details, review the revision history included in any revised document.

12.4 Support Resources

TI E2E™ support forums are an engineer's go-to source for fast, verified answers and design help — straight from the experts. Search existing answers or ask your own question to get the quick design help you need.

Linked content is provided "AS IS" by the respective contributors. They do not constitute TI specifications and do not necessarily reflect TI's views; see TI's [Terms of Use](#).

12.5 Trademarks

E2E is a trademark of Texas Instruments.

12.6 Electrostatic Discharge Caution



This integrated circuit can be damaged by ESD. Texas Instruments recommends that all integrated circuits be handled with appropriate precautions. Failure to observe proper handling and installation procedures can cause damage.

ESD damage can range from subtle performance degradation to complete device failure. Precision integrated circuits may be more susceptible to damage because very small parametric changes could cause the device not to meet its published specifications.

12.7 Glossary

[SLYZ022](#) — *TI Glossary*.

This glossary lists and explains terms, acronyms, and definitions.

13 Mechanical, Packaging, and Orderable Information

The following pages include mechanical, packaging, and orderable information. This information is the most current data available for the designated devices. This data is subject to change without notice and revision of this document. For browser-based versions of this data sheet, refer to the left-hand navigation.



PACKAGING INFORMATION

Orderable Device	Status (1)	Package Type	Package Drawing	Pins	Package Qty	Eco Plan (2)	Lead finish/ Ball material (6)	MSL Peak Temp (3)	Op Temp (°C)	Device Marking (4/5)	Samples
PCF8575DB	ACTIVE	SSOP	DB	24	60	RoHS & Green	NIPDAU	Level-1-260C-UNLIM	-40 to 85	PF575	Samples
PCF8575DBQR	ACTIVE	SSOP	DBQ	24	2500	RoHS & Green	NIPDAU	Level-2-260C-1 YEAR	-40 to 85	PCF8575	Samples
PCF8575DBQRG4	ACTIVE	SSOP	DBQ	24	2500	RoHS & Green	NIPDAU	Level-2-260C-1 YEAR	-40 to 85	PCF8575	Samples
PCF8575DBR	ACTIVE	SSOP	DB	24	2000	RoHS & Green	NIPDAU	Level-1-260C-UNLIM	-40 to 85	PF575	Samples
PCF8575DBRE4	ACTIVE	SSOP	DB	24	2000	RoHS & Green	NIPDAU	Level-1-260C-UNLIM	-40 to 85	PF575	Samples
PCF8575DGVR	ACTIVE	TVSOP	DGV	24	2000	RoHS & Green	NIPDAU	Level-1-260C-UNLIM	-40 to 85	PF575	Samples
PCF8575DGVRG4	ACTIVE	TVSOP	DGV	24	2000	RoHS & Green	NIPDAU	Level-1-260C-UNLIM	-40 to 85	PF575	Samples
PCF8575DW	ACTIVE	SOIC	DW	24	25	RoHS & Green	NIPDAU	Level-1-260C-UNLIM	-40 to 85	PCF8575	Samples
PCF8575DWR	ACTIVE	SOIC	DW	24	2000	RoHS & Green	NIPDAU	Level-1-260C-UNLIM	-40 to 85	PCF8575	Samples
PCF8575PW	ACTIVE	TSSOP	PW	24	60	RoHS & Green	NIPDAU	Level-1-260C-UNLIM	-40 to 85	PF575	Samples
PCF8575PWE4	ACTIVE	TSSOP	PW	24	60	RoHS & Green	NIPDAU	Level-1-260C-UNLIM	-40 to 85	PF575	Samples
PCF8575PWR	ACTIVE	TSSOP	PW	24	2000	RoHS & Green	NIPDAU	Level-1-260C-UNLIM	-40 to 85	PF575	Samples
PCF8575PWRE4	ACTIVE	TSSOP	PW	24	2000	RoHS & Green	NIPDAU	Level-1-260C-UNLIM	-40 to 85	PF575	Samples
PCF8575RGER	ACTIVE	VQFN	RGE	24	3000	RoHS & Green	NIPDAU	Level-2-260C-1 YEAR	-40 to 85	PF575	Samples

(1) The marketing status values are defined as follows:

ACTIVE: Product device recommended for new designs.

LIFEBUY: TI has announced that the device will be discontinued, and a lifetime-buy period is in effect.

NRND: Not recommended for new designs. Device is in production to support existing customers, but TI does not recommend using this part in a new design.

PREVIEW: Device has been announced but is not in production. Samples may or may not be available.

OBSOLETE: TI has discontinued the production of the device.

(2) **RoHS:** TI defines "RoHS" to mean semiconductor products that are compliant with the current EU RoHS requirements for all 10 RoHS substances, including the requirement that RoHS substance do not exceed 0.1% by weight in homogeneous materials. Where designed to be soldered at high temperatures, "RoHS" products are suitable for use in specified lead-free processes. TI may reference these types of products as "Pb-Free".

RoHS Exempt: TI defines "RoHS Exempt" to mean products that contain lead but are compliant with EU RoHS pursuant to a specific EU RoHS exemption.

Green: TI defines "Green" to mean the content of Chlorine (Cl) and Bromine (Br) based flame retardants meet JS709B low halogen requirements of ≤ 1000 ppm threshold. Antimony trioxide based flame retardants must also meet the ≤ 1000 ppm threshold requirement.

(3) MSL, Peak Temp. - The Moisture Sensitivity Level rating according to the JEDEC industry standard classifications, and peak solder temperature.

(4) There may be additional marking, which relates to the logo, the lot trace code information, or the environmental category on the device.

(5) Multiple Device Markings will be inside parentheses. Only one Device Marking contained in parentheses and separated by a "~" will appear on a device. If a line is indented then it is a continuation of the previous line and the two combined represent the entire Device Marking for that device.

(6) Lead finish/Ball material - Orderable Devices may have multiple material finish options. Finish options are separated by a vertical ruled line. Lead finish/Ball material values may wrap to two lines if the finish value exceeds the maximum column width.

Important Information and Disclaimer: The information provided on this page represents TI's knowledge and belief as of the date that it is provided. TI bases its knowledge and belief on information provided by third parties, and makes no representation or warranty as to the accuracy of such information. Efforts are underway to better integrate information from third parties. TI has taken and continues to take reasonable steps to provide representative and accurate information but may not have conducted destructive testing or chemical analysis on incoming materials and chemicals. TI and TI suppliers consider certain information to be proprietary, and thus CAS numbers and other limited information may not be available for release.

In no event shall TI's liability arising out of such information exceed the total purchase price of the TI part(s) at issue in this document sold by TI to Customer on an annual basis.

 **SKYTECH**
ELECTRONIC

TAPE AND REEL INFORMATION

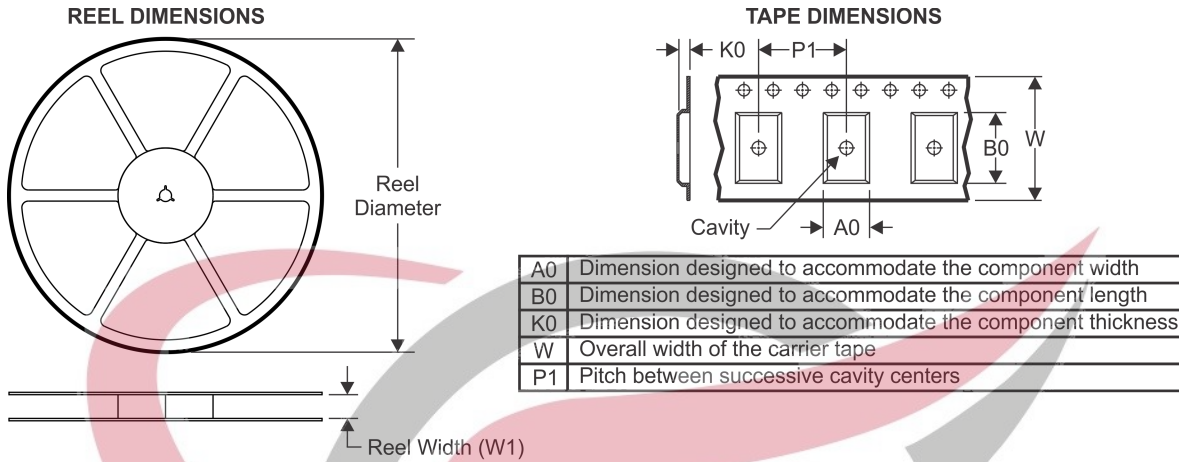

QUADRANT ASSIGNMENTS FOR PIN 1 ORIENTATION IN TAPE

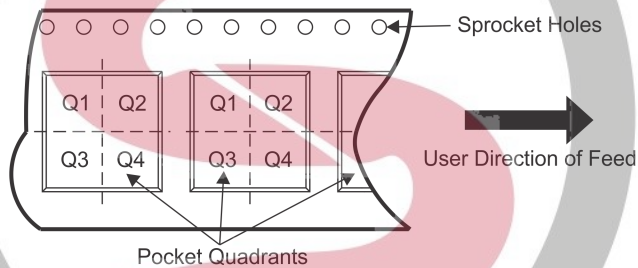

*All dimensions are nominal

Device	Package Type	Package Drawing	Pins	SPQ	Reel Diameter (mm)	Reel Width W1 (mm)	A0 (mm)	B0 (mm)	K0 (mm)	P1 (mm)	W (mm)	Pin1 Quadrant
PCF8575DBQR	SSOP	DBQ	24	2500	330.0	16.4	6.5	9.0	2.1	8.0	16.0	Q1
PCF8575DBR	SSOP	DB	24	2000	330.0	16.4	8.2	8.8	2.5	12.0	16.0	Q1
PCF8575DGVR	TVSOP	DGV	24	2000	330.0	12.4	6.9	5.6	1.6	8.0	12.0	Q1
PCF8575DWR	SOIC	DW	24	2000	330.0	24.4	10.75	15.7	2.7	12.0	24.0	Q1
PCF8575PWR	TSSOP	PW	24	2000	330.0	16.4	6.95	8.3	1.6	8.0	16.0	Q1
PCF8575RGER	VQFN	RGE	24	3000	330.0	12.4	4.25	4.25	1.15	8.0	12.0	Q2

TAPE AND REEL BOX DIMENSIONS

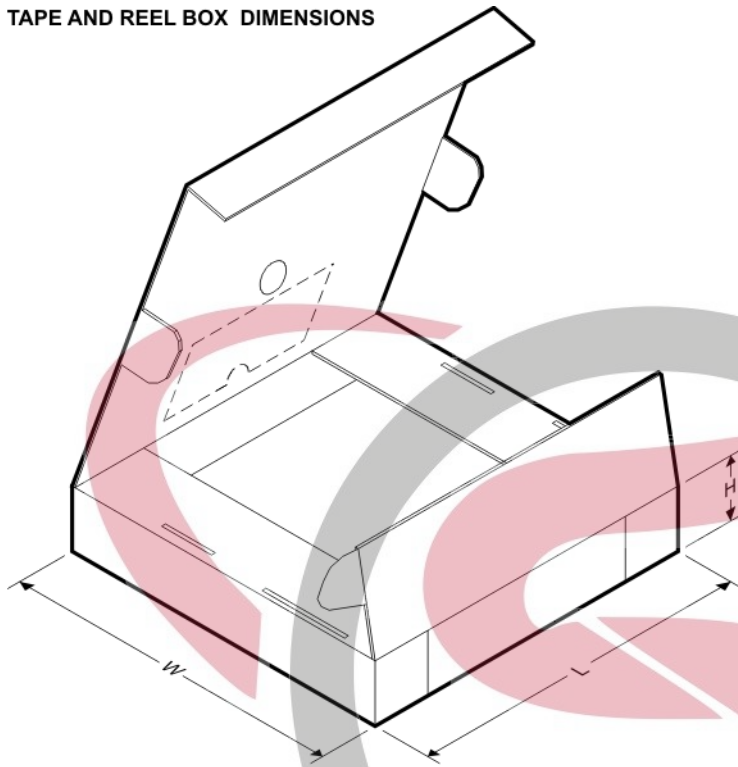

*All dimensions are nominal

Device	Package Type	Package Drawing	Pins	SPQ	Length (mm)	Width (mm)	Height (mm)
PCF8575DBQR	SSOP	DBQ	24	2500	853.0	449.0	35.0
PCF8575DBR	SSOP	DB	24	2000	853.0	449.0	35.0
PCF8575DGVR	TVSOP	DGV	24	2000	853.0	449.0	35.0
PCF8575DWR	SOIC	DW	24	2000	350.0	350.0	43.0
PCF8575PWR	TSSOP	PW	24	2000	853.0	449.0	35.0
PCF8575RGER	VQFN	RGE	24	3000	853.0	449.0	35.0

SKYTECH
ELECTRONIC

RGE 24

GENERIC PACKAGE VIEW

VQFN - 1 mm max height

PLASTIC QUAD FLATPACK - NO LEAD

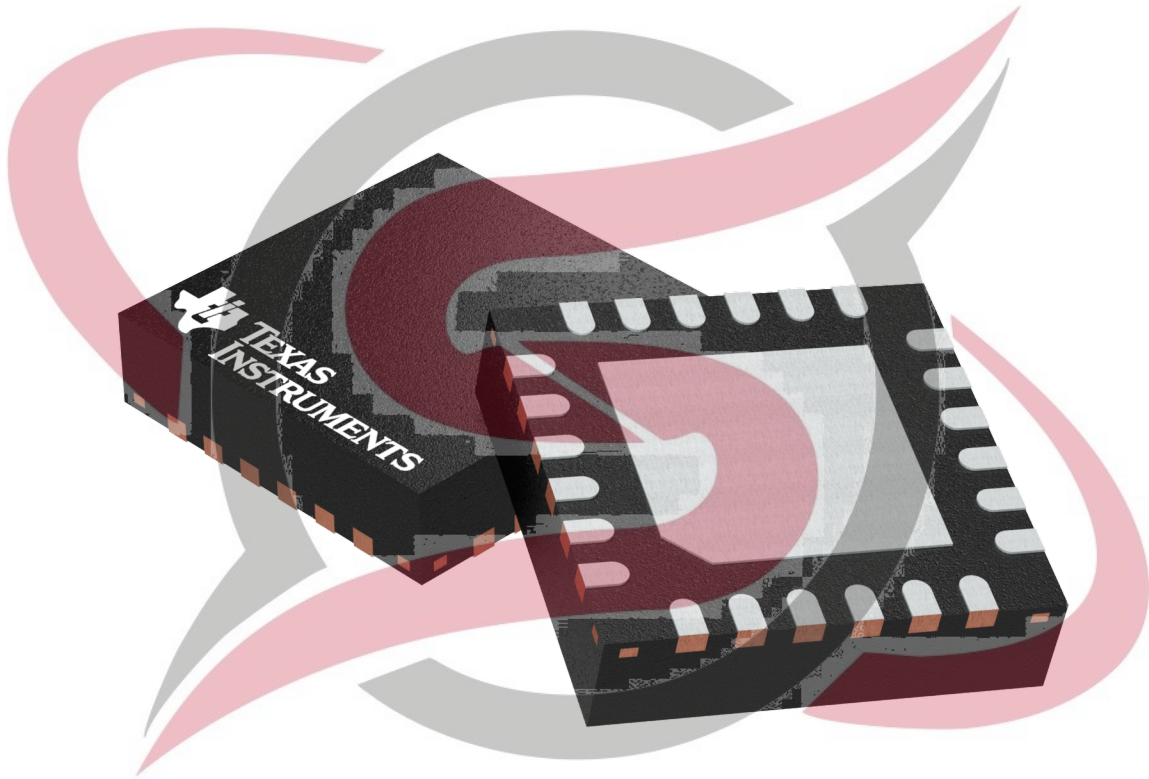

SKYTECH
ELECTRONIC

Images above are just a representation of the package family, actual package may vary.
Refer to the product data sheet for package details.

4204104/H



published by WWW.SKYTECH.IR

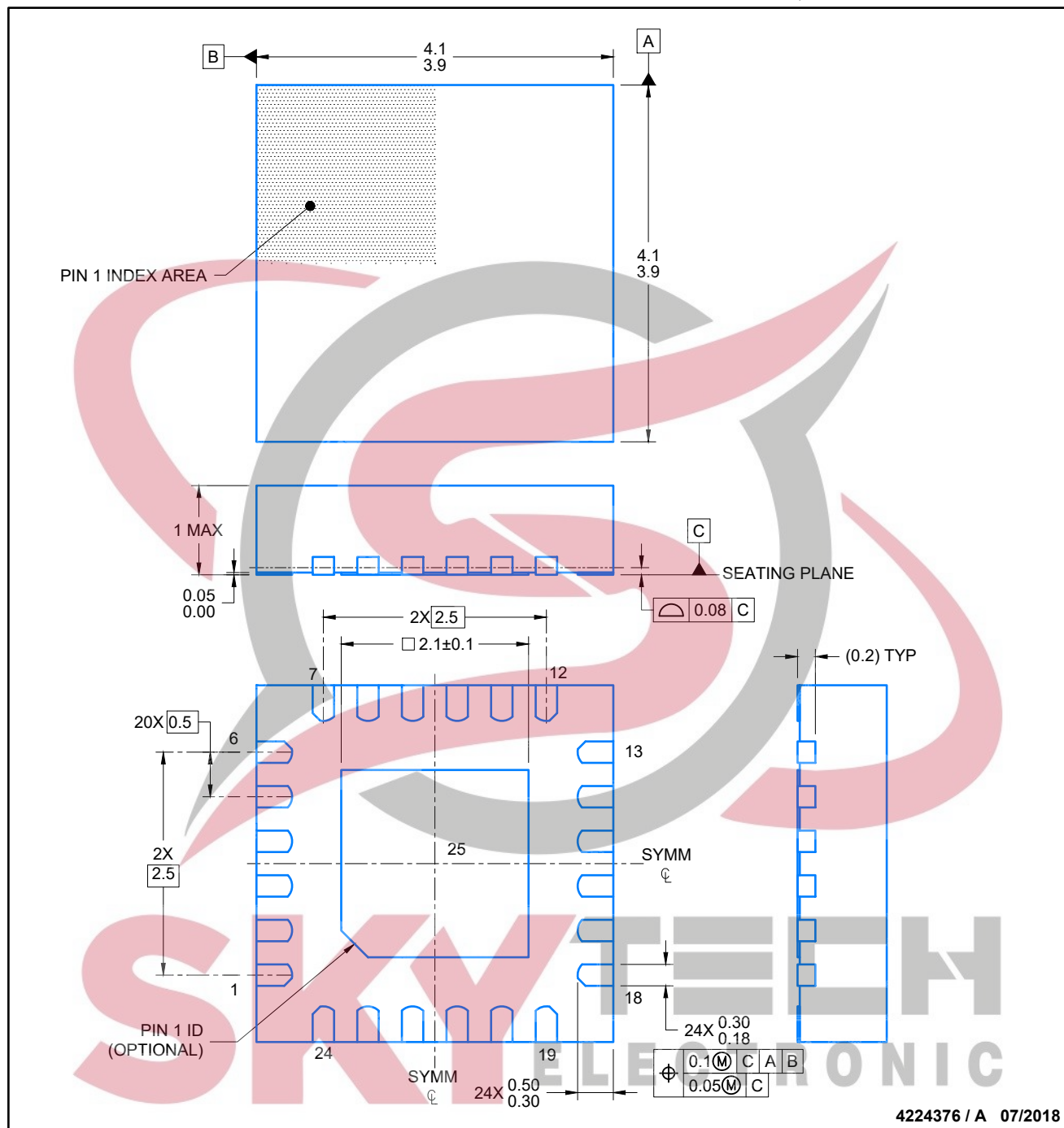

NOTES:

1. All linear dimensions are in millimeters. Any dimensions in parenthesis are for reference only. Dimensioning and tolerancing per ASME Y14.5M.
2. This drawing is subject to change without notice.
3. The package thermal pad must be soldered to the printed circuit board for thermal and mechanical performance.

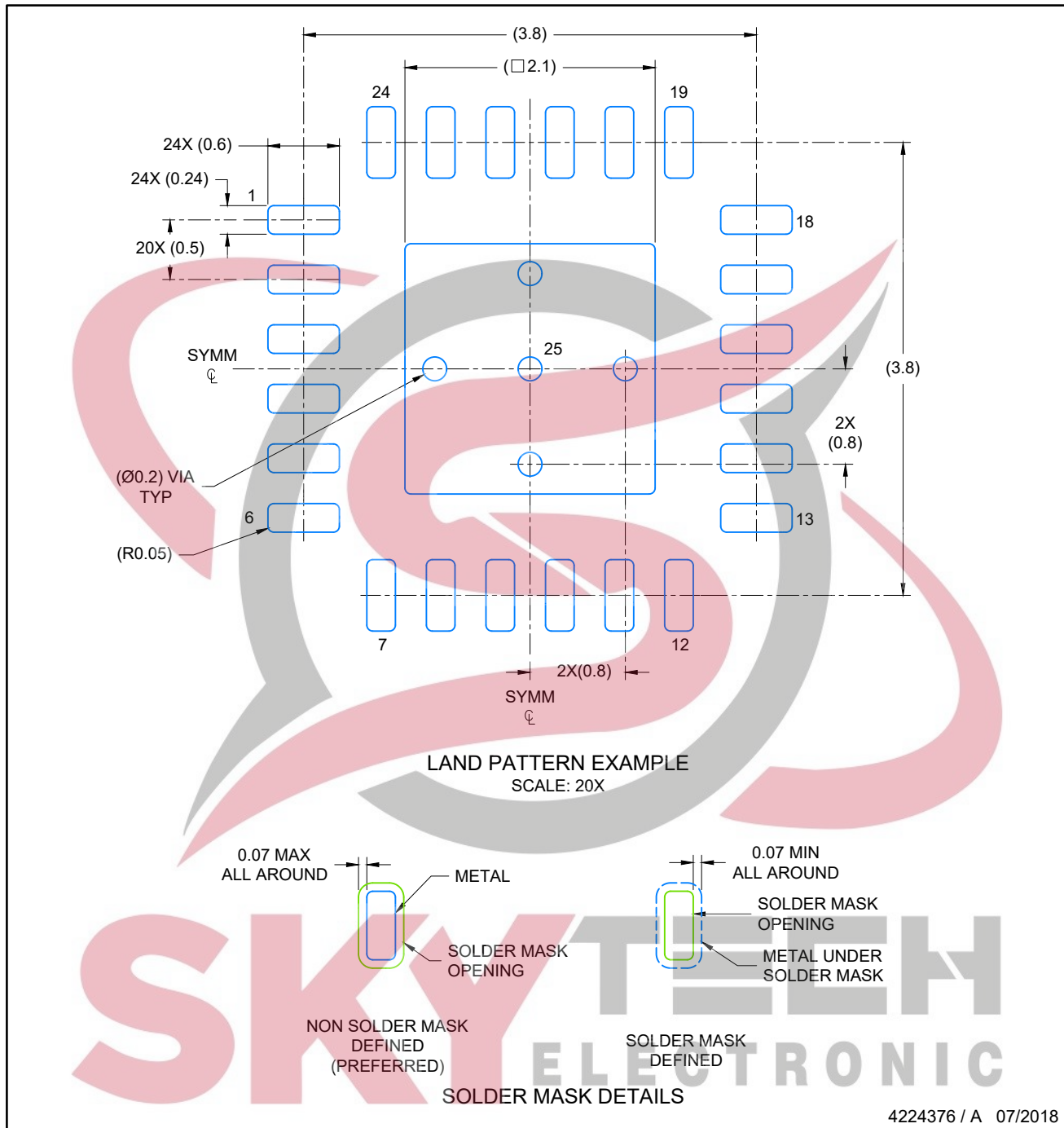

NOTES: (continued)

4. This package is designed to be soldered to a thermal pad on the board. For more information, see Texas Instruments literature number SLUA271 (www.ti.com/lit/slua271).
5. Solder mask tolerances between and around signal pads can vary based on board fabrication site.

EXAMPLE STENCIL DESIGN

VQFN - 1 mm max height

RGE0024C

PLASTIC QUAD FLATPACK- NO LEAD

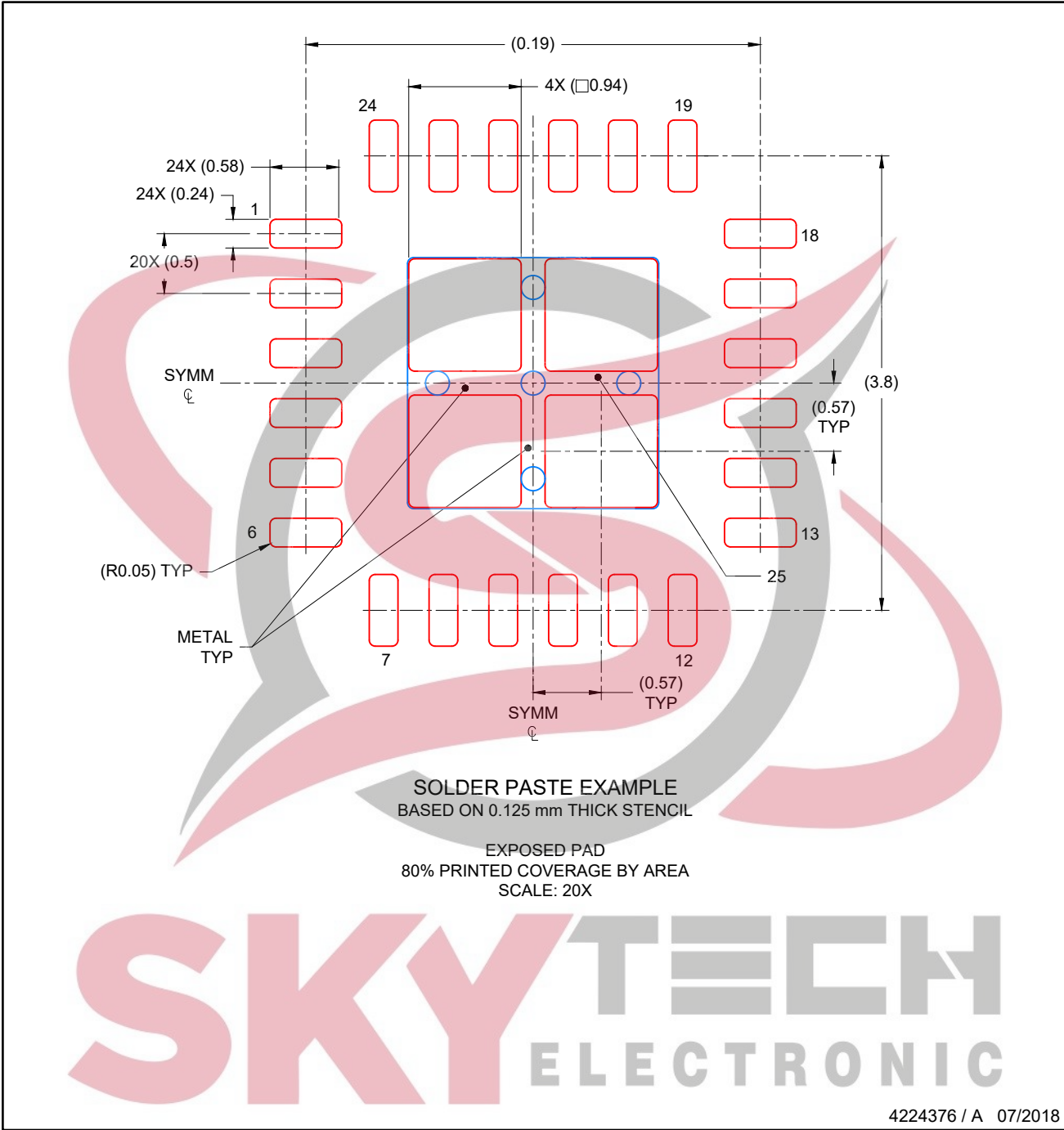

NOTES: (continued)

- 6. Laser cutting apertures with trapezoidal walls and rounded corners may offer better paste release. IPC-7525 may have alternate design recommendations..

DBQ (R-PDSO-G24)

PLASTIC SMALL-OUTLINE PACKAGE

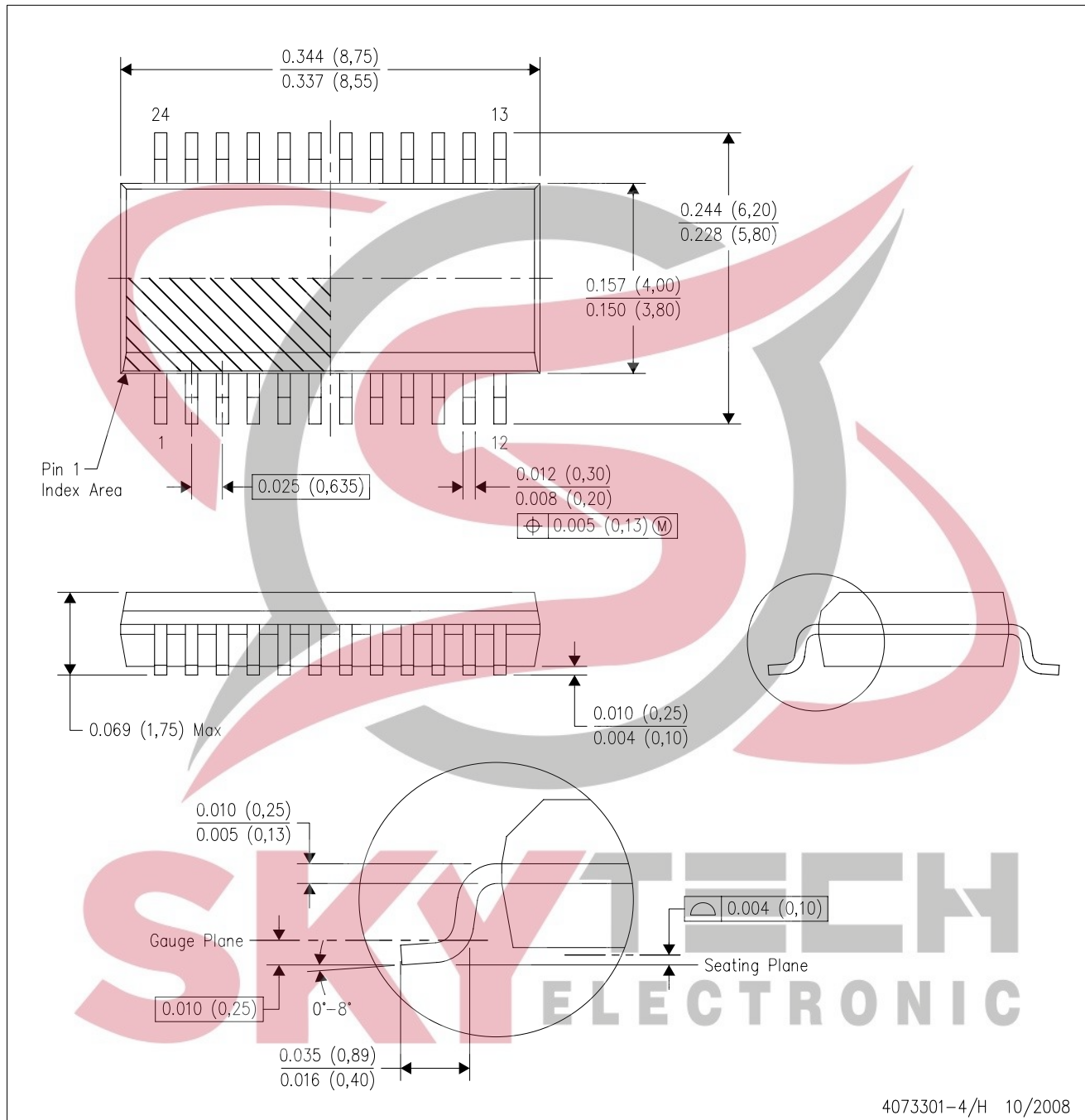

- NOTES:
- All linear dimensions are in inches (millimeters).
 - This drawing is subject to change without notice.
 - Body dimensions do not include mold flash or protrusion not to exceed 0.006 (0,15) per side.
 - Falls within JEDEC MO-137 variation AE.

PW0024A



PACKAGE OUTLINE
TSSOP - 1.2 mm max height

SMALL OUTLINE PACKAGE

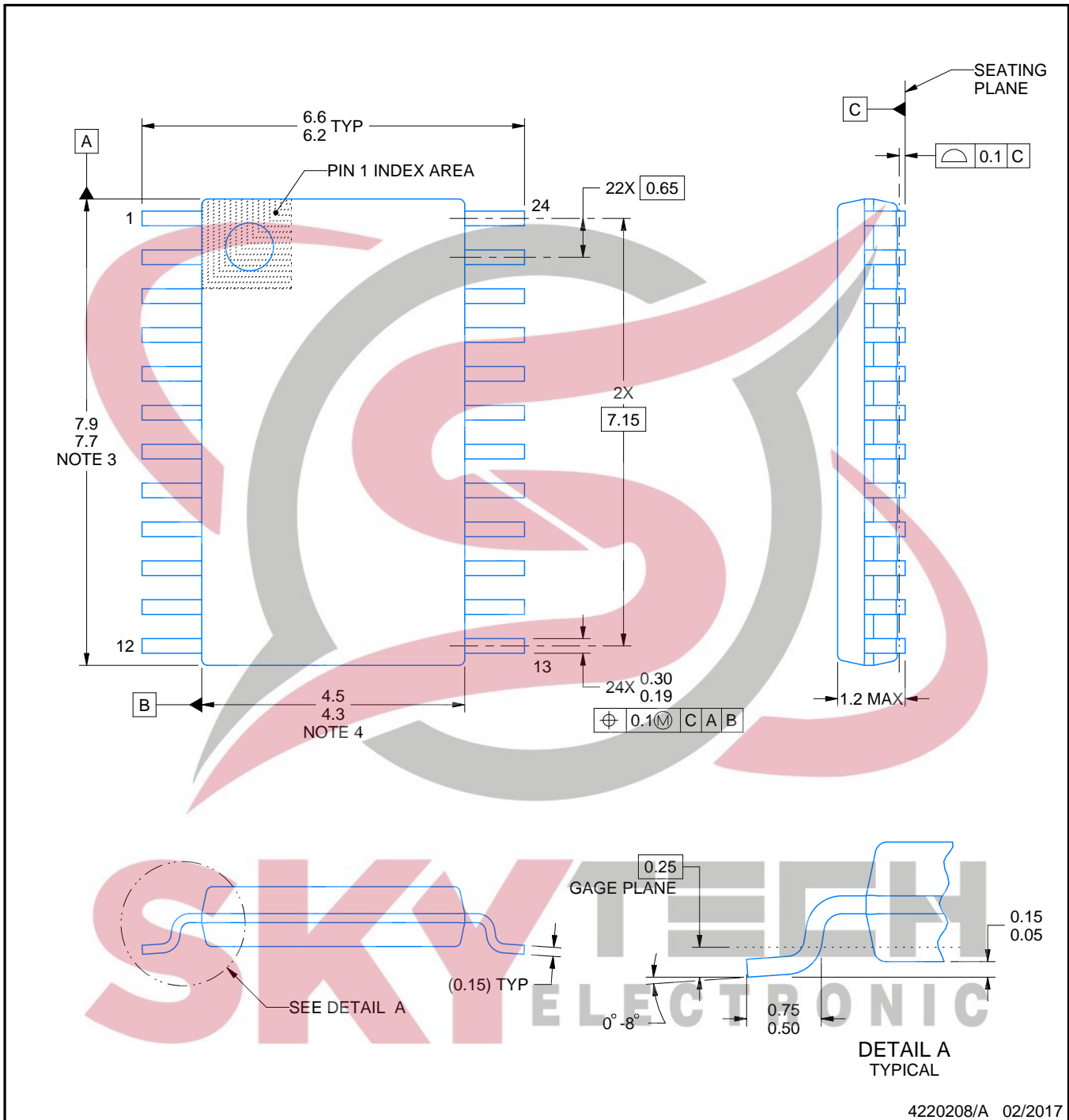

NOTES:

1. All linear dimensions are in millimeters. Any dimensions in parenthesis are for reference only. Dimensioning and tolerancing per ASME Y14.5M.
2. This drawing is subject to change without notice.
3. This dimension does not include mold flash, protrusions, or gate burrs. Mold flash, protrusions, or gate burrs shall not exceed 0.15 mm per side.
4. This dimension does not include interlead flash. Interlead flash shall not exceed 0.25 mm per side.
5. Reference JEDEC registration MO-153.



EXAMPLE BOARD LAYOUT

PW0024A

TSSOP - 1.2 mm max height

SMALL OUTLINE PACKAGE

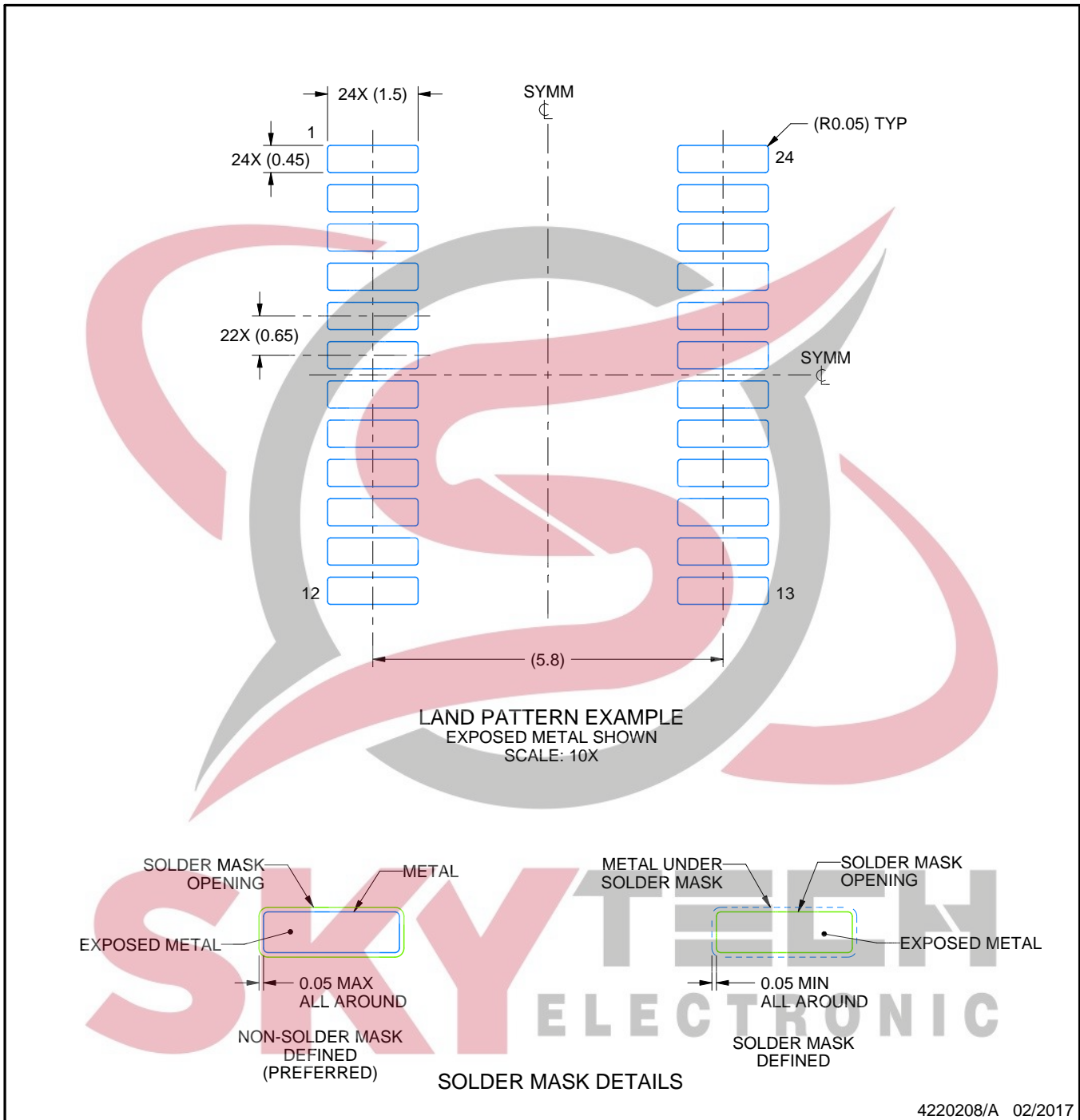

NOTES: (continued)

- 6. Publication IPC-7351 may have alternate designs.
- 7. Solder mask tolerances between and around signal pads can vary based on board fabrication site.

EXAMPLE STENCIL DESIGN

PW0024A

TSSOP - 1.2 mm max height

SMALL OUTLINE PACKAGE

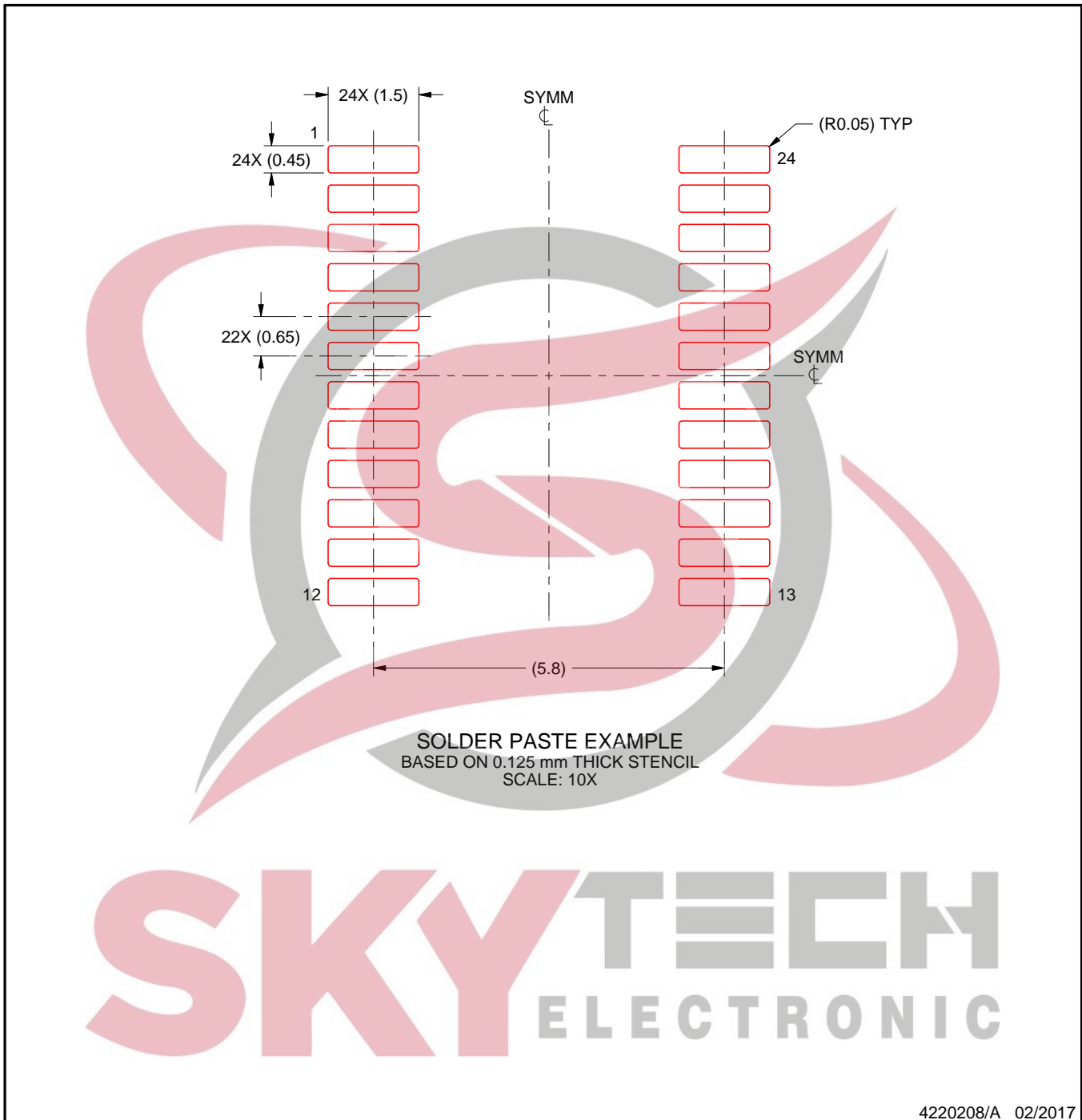

NOTES: (continued)

8. Laser cutting apertures with trapezoidal walls and rounded corners may offer better paste release. IPC-7525 may have alternate design recommendations.
9. Board assembly site may have different recommendations for stencil design.

DW (R-PDSO-G24)

PLASTIC SMALL OUTLINE

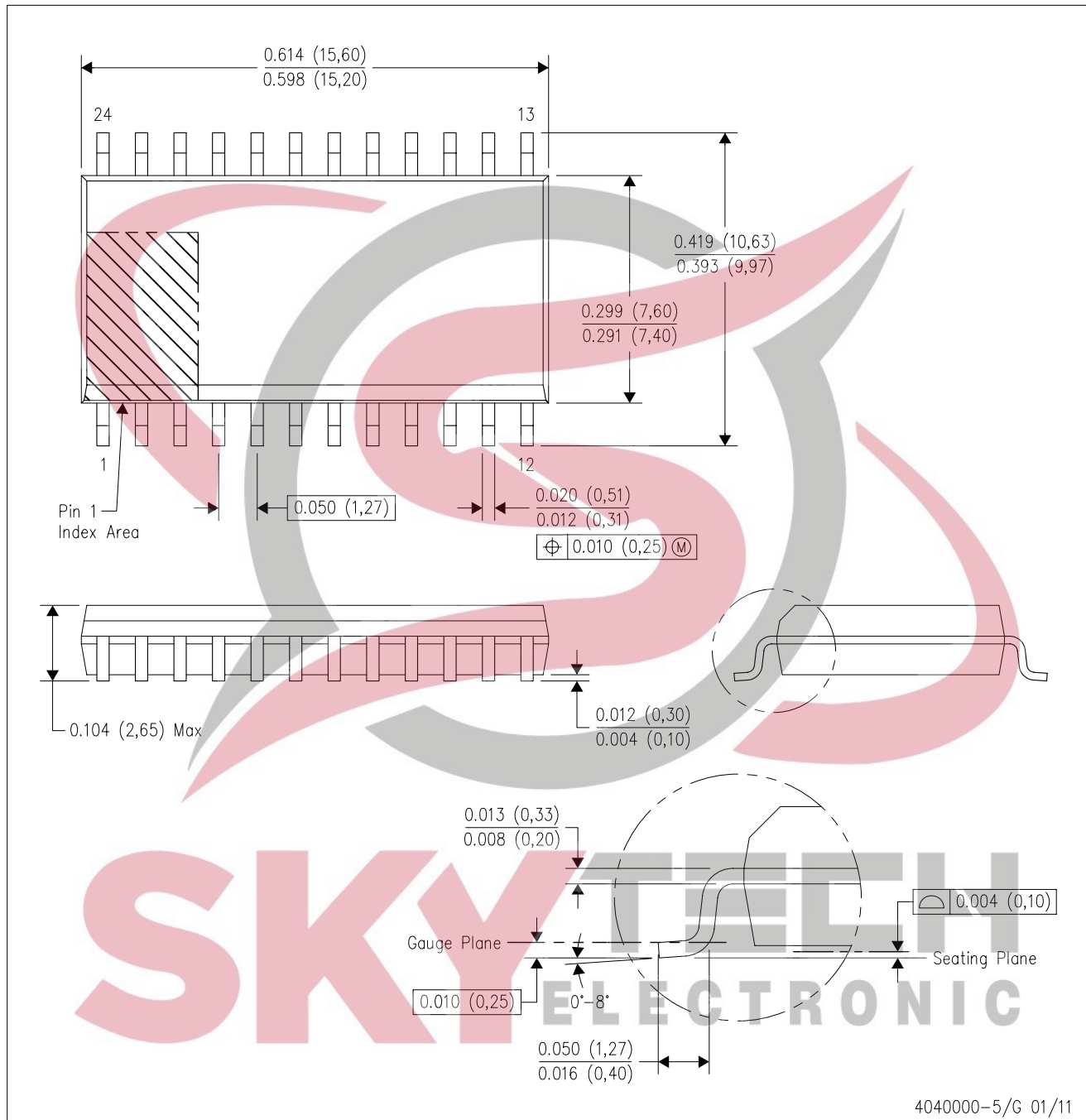

- NOTES:
- All linear dimensions are in inches (millimeters). Dimensioning and tolerancing per ASME Y14.5M-1994.
 - This drawing is subject to change without notice.
 - Body dimensions do not include mold flash or protrusion not to exceed 0.006 (0,15).
 - Falls within JEDEC MS-013 variation AD.

DB (R-PDSO-G**)

PLASTIC SMALL-OUTLINE

28 PINS SHOWN

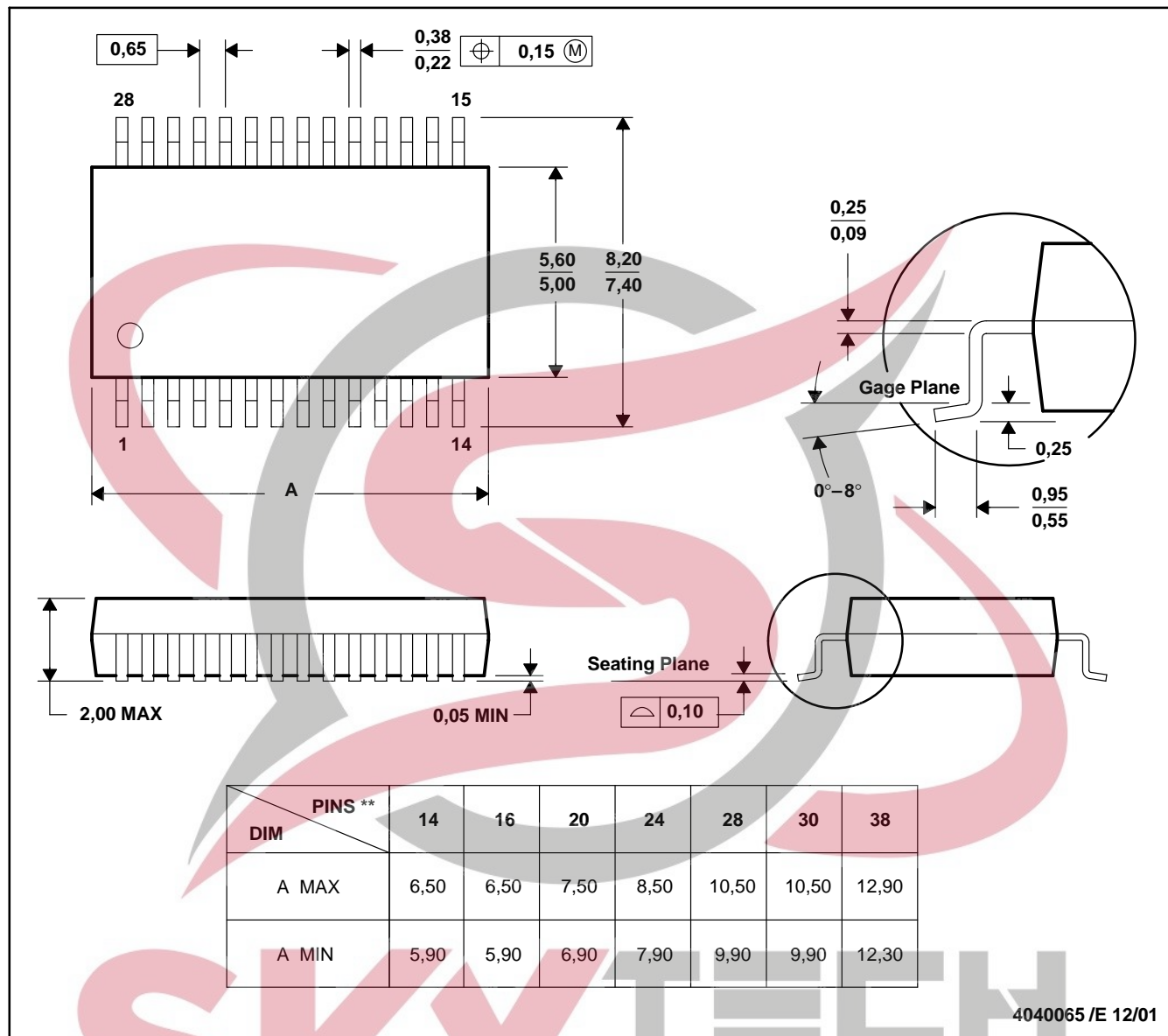

- NOTES: A. All linear dimensions are in millimeters.
 B. This drawing is subject to change without notice.
 C. Body dimensions do not include mold flash or protrusion not to exceed 0,15.
 D. Falls within JEDEC MO-150

IMPORTANT NOTICE AND DISCLAIMER

TI PROVIDES TECHNICAL AND RELIABILITY DATA (INCLUDING DATASHEETS), DESIGN RESOURCES (INCLUDING REFERENCE DESIGNS), APPLICATION OR OTHER DESIGN ADVICE, WEB TOOLS, SAFETY INFORMATION, AND OTHER RESOURCES "AS IS" AND WITH ALL FAULTS, AND DISCLAIMS ALL WARRANTIES, EXPRESS AND IMPLIED, INCLUDING WITHOUT LIMITATION ANY IMPLIED WARRANTIES OF MERCHANTABILITY, FITNESS FOR A PARTICULAR PURPOSE OR NON-INFRINGEMENT OF THIRD PARTY INTELLECTUAL PROPERTY RIGHTS.

These resources are intended for skilled developers designing with TI products. You are solely responsible for (1) selecting the appropriate TI products for your application, (2) designing, validating and testing your application, and (3) ensuring your application meets applicable standards, and any other safety, security, or other requirements. These resources are subject to change without notice. TI grants you permission to use these resources only for development of an application that uses the TI products described in the resource. Other reproduction and display of these resources is prohibited. No license is granted to any other TI intellectual property right or to any third party intellectual property right. TI disclaims responsibility for, and you will fully indemnify TI and its representatives against, any claims, damages, costs, losses, and liabilities arising out of your use of these resources.

TI's products are provided subject to TI's Terms of Sale (www.ti.com/legal/termsofsale.html) or other applicable terms available either on ti.com or provided in conjunction with such TI products. TI's provision of these resources does not expand or otherwise alter TI's applicable warranties or warranty disclaimers for TI products.

Mailing Address: Texas Instruments, Post Office Box 655303, Dallas, Texas 75265
Copyright © 2020, Texas Instruments Incorporated



SKYTECH
ELECTRONIC